

TRACTION CATALOGUE



**WEST
COAST
WEAR**
PRODUCTS LTD.

1-866-307-6622

www.westcoastwearproducts.com

CHAIN CLASSIFICATION & SIZING

S.A.E. CLASSIFICATIONS

SAE Class "S"

Regular (non-reinforced) passenger tire chains and cables for vehicles with restricted wheel well clearances.
 1.46" clearance on tread-face, 0.59" clearance on side-wall.

SAE Class "U"

Regular (non-reinforced) and lug reinforced passenger tire chains for vehicles with regular (non-restricted) wheel well clearances.
 1.97" clearance on tread-face, 0.91" clearance on side-wall.

SAE Class "W"

Those passenger tire chains that use light truck components, as well as some light truck chains.
 2.50" clearance on tread face, 1.50" clearance on side-wall.

TIRE CLEARANCE

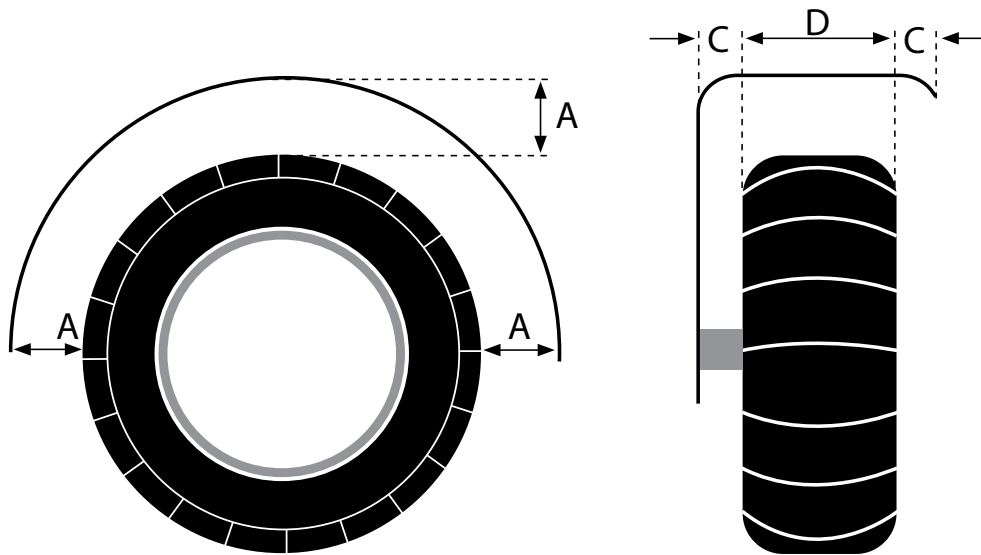

TIRE CHAIN IDENTIFICATION	MINIMUM DIMENSIONS	MINIMUM DIMENSIONS
	A	C
SAE CLASS "S"	37mm (1.46")	15mm (0.59")
SAE CLASS "U"	50mm (1.97")	23mm (0.91")
SAE CLASS "W"	63.5mm (2.5")	38.1mm (1.5")

NOTE: For design purposes, "D" is the maximum crown tire section width as established by the Tire and Rim Association (TRA). The minimum clearances specified must be maintained around spring clips, spring bolts, fenders, braces, splash pans, fuel lines, brake lines, brake controls, and wherever necessary.

Tire size must be known in order to select a tire chain of correct fit. For passenger cars, vans, and small pick-up trucks, it is important to check the owner's manual. The restricted wheel clearances in most of today's downsized and front drive vehicles may require the use of SAE Class "S" tire chains, as noted. Check your owners manual for information regarding your vehicle.

PASSENGER

TIRE SIZE	EASYSOX	CRUZ CABLES	VOLT PREMIUM DIAGONAL CABLES	NAVIGATOR SQUARE LINK ALLOY	TIRE SIZE	EASYSOX	CRUZ CABLES	VOLT PREMIUM DIAGONAL CABLES	NAVIGATOR SQUARE LINK ALLOY	
	PAGE 6	PAGE 4	PAGE 5	PAGE 5		PAGE 6	PAGE 4	PAGE 5	PAGE 5	
13" RIMS	155/70R13		1014		1510Q					
	155/80R13	ES81	1014	QV315	1515Q					
	165/65R13		1018		1510Q					
	165/70R13		1014		1515Q					
	165/80R13		1018		1520Q					
	175/70R13		1018		1520Q					
	185/70R13	ES72	1026	QV319	1525Q					
14" RIMS	155/65R14		1014		1510Q					
	165/65R14		1018		1515Q					
	165/70R14		1018		1520Q					
	175/65R14	ES81	1018	QV315	1520Q					
	175/70R14	ES72	1026	QV319	1525Q					
	185/60R14	ES81	1018	QV319	1520Q					
	185/70R14	ES77	1026	QV323	1530Q					
	185/75R14		1026		1530Q					
	195/60R14	ES72	1026	QV319	1525Q					
	195/65R14		1026		1530Q					
	195/70R14	ES78	1030	QV327	1535Q					
	195/75R14	ES79	1030	QV323	1535Q					
	205/70R14	ES73	1034	QV329	1540Q					
	205/75R14	ES79	1034	QV331	1540Q					
	215/60R14		1030		1535Q					
	215/75R14	ES75	1034	QV335	1545Q					
	225/60R14				2319LW 2519Q					
	225/70R14		1038		1545Q					
	15" RIMS	165/60R15	ES81		QV315	1520Q				
		165/65R15	ES72	1022	QV319	1525Q				
165/80R15		ES73	1022	QV323	1530Q					
175/55R15		ES81	1018	QV315	1520Q					
175/60R15		ES72		QV319	1525Q					
175/65R15		ES77	1022	QV319	1525Q					
185/55R15		ES81	1022	QV319	1525Q					
185/60R15		ES72	1026	QV323	1525Q					
185/65R15		ES77	1026	QV323	1530Q					
195/50R15		ES81	1026	QV319	1525Q					
195/55R15		ES72	1022	QV323	1525Q					
195/60R15		ES77	1030	QV327	1530Q					
195/65R15		ES73	1030	QV329	1535Q					
195/70R15		ES79	1034	QV329	1540Q					
205/50R15		ES76	1026	QV323	1525Q					
205/55R15		ES77	1034	QV327	1535Q					
205/60R15		ES78	1030	QV331	1535Q					
205/65R15		ES79	1034	QV329	1540Q					
205/70R15		ES74	1034	QV335	1545Q					
15" RIMS		205/75R15	ES75	1034	QV335	1545Q				
		215/60R15	ES73	1034	QV331	1540Q				
		215/65R15	ES79	1038	QV335	1545Q				
		215/70R15	ES74	1038	QV335	1550Q				
		215/75R15	ES80	1038	QV339	1550Q				
	225/50R15	ES77	1030	QV327	1535Q					
	225/60R15	ES79	1034	QV331	1547Q					
	225/70R15	ES75	1038	QV343	1553Q					
	225/75R15	ES80	1042	QV343	1555Q					
	235/60R15	ES79	1038	QV335	1550Q					
	235/70R15	ES83	1042	QV343 QV729	1555Q					
	235/75R15	ES82	1042	QV343 QV729	1555Q					
	245/60R15	ES74	1042	QV339	1553Q					
	255/60R15	ES75	1042	QV343	1555Q					
	255/70R15	ES83	1046	QV735	1555Q					
	275/50R15		1042	QV339	1555Q					
	275/60R15	ES83	1046	QV729	1555Q					
	295/50R15	ES80	1046	QV339						
	16" RIMS	195/50R16	ES76	1030	QV323	1530Q				
		195/55R16	ES77	1030	QV327	1540Q				
		195/60R16	ES73	1030	QV329	1535Q				
		195/65R16	ES79	1034	QV329					
		205/40R16	ES81	1026	QV323	1525Q				
		205/45R16	ES76	1030	QV323	1525Q				
205/50R16		ES77	1034	QV327	1535Q					
205/55R16		ES78	1034	QV331	1540Q					
205/60R16		ES79	1034	QV331	1545Q					
205/65R16		ES74	1038	QV335	1547Q					
205/70R16		ES75	1038	QV335	1547Q					
215/45R16		ES76	1030	QV323	1535Q					
215/50R16		ES77	1034	QV331						
215/55R16		ES73	1034	QV331	1545Q					
215/60R16		ES79	1038	QV335	1545Q					
215/65R16		ES74	1038	QV335	1550Q					
215/70R16		ES80	1038	QV339	1550Q					
225/45R16		ES77	1034		1540Q					
225/50R16		ES78	1034	QV335	1545Q					
225/55R16		ES79	1038	QV335	1547Q					
225/60R16		ES74	1038	QV339	1550Q					
225/65R16		ES80	1038	QV339	1553Q					
225/70R16		ES82	1042	QV343	1555Q					
235/55R16		ES79	1038	QV339						
235/60R16	ES75	1042	QV339	1553Q						
235/65R16	ES80	1042		1555Q						

PASSENGER

TIRE SIZE	EASYSOX	CRUZ CABLES	VOLT PREMIUM DIAGONAL CABLES	NAVIGATOR SQUARE LINK ALLOY		
	PAGE 6	PAGE 4	PAGE 5	PAGE 5		
16" RIMS	245/45R16	ES78	1038	QV331	1547Q	
	245/50R16	ES79	1038	QV339	1555Q	
	255/50R16	ES79	1042	QV343	1555Q	
	255/65R16		1042		2319LW 2519Q	
13" RIMS	205/40R17	ES76	1026	QV323	1530Q	
	205/45R17	ES77	1030	QV327	1535Q	
	205/50R17	ES73	1034	QV331	1545Q	
	215/40R17	ES77	1034	QV327	1535Q	
	215/45R17	ES78	1030	QV331	1540Q	
	215/50R17	ES79	1038	QV331	1547Q	
	215/55R17	ES74	1038	QV335	1545Q	
	215/60R17	ES75	1042	QV339	1553Q	
	215/65R17	ES80	1042	QV339	1555Q	
	225/45R17	ES78	1034	QV335	1545Q	
	225/50R17	ES79	1038	QV335	1547Q	
	225/55R17	ES74	1042	QV339	1550Q	
	225/60R17	ES80	1042	QV339	1555Q	
	225/65R17	ES82	1042	QV343	2317LW 2517Q	
17" RIMS	235/40R17	ES77	1034	QV335	1540Q	
	235/45R17	ES73	1038	QV335	1545Q	
	235/50R17	ES79	1042	QV339	1550Q	
	235/55R17	ES75	1042	QV343	1553Q	
	235/60R17	ES80	1042	QV343	1555Q	
	235/65R17	ES82	1046	QV729	2319LW 2519Q	
	245/40R17	ES78	1038	QV335	1547Q	
	245/45R17	ES79	1042	QV343	1547Q	
	245/50R17	ES74	1042	QV339	1553Q	
	245/65R17	ES83	1046	QV735	2319LW 2519Q	
	255/40R17	ES73	1038	QV335	1547Q	
	255/45R17	ES79	1042	QV339	1553Q	
	255/50R17	ES75	1042	QV343	1555Q	
	275/40R17	ES79	1042	QV343	1553Q	
	275/50R17		1669		2319LW 2519Q	
	285/40R17	ES80	1046	QV339		
	18" RIMS	215/35R18	ES77	1030	QV327	1535Q
		215/40R18	ES78	1034	QV331	1547Q
215/45R18		ES79	1038	QV331	1547Q	
215/55R18		ES75	1042	QV339	1553Q	
225/40R18		ES73	1034	QV335	1547Q	
225/45R18		ES79	1038	QV335	1550Q	
225/50R18		ES75	1042	QV339	1553Q	
225/55R18		ES80	1042	QV339 QV729	1553Q	
225/60R18		ES82	1046	QV729	1555Q	
235/40R18		ES79	1038	QV335	1547Q	

TIRE SIZE	EASYSOX	CRUZ CABLES	VOLT PREMIUM DIAGONAL CABLES	NAVIGATOR SQUARE LINK ALLOY	
	PAGE 6	PAGE 4	PAGE 5	PAGE 5	
18" RIMS	235/45R18	ES74	1042	QV339	1553Q
	235/50R18	ES75	1046	QV343	1555Q
	235/55R18	ES80	1046	QV729	2317LW 2517Q
	235/60R18	ES82	1046	QV729	2319LW 2519Q
	235/65R18			QV735	2319LW 2519Q
	245/40R18	ES79	1038	QV339	1550Q
	245/45R18	ES75	1042	QV343	1550Q
	245/50R18	ES80	1042	QV343	1555Q
	255/35R18	ES73	1038	QV335	1550Q
	255/40R18	ES79	1042	QV343	1553Q
	255/45R18	ES75	1042	QV343	1555Q
	255/55R18	ES82	1046	QV735	2319LW 2519Q
	265/35R18	ES79	1042	QV339	1550Q
	265/40R18	ES74	1042	QV343	1553Q
	275/35R18	ES79	1046	QV343	1550Q
	275/40R18	ES80	1046	QV343	1555Q
	275/45R18	ES80	1046	QV735	2319LW
	19" RIMS	285/30R18		1046	QV335
285/35R18		ES80	1046	QV339	
215/35R19			1034	QV331	
225/35R19		ES79	1038	QV323	1545Q
225/55R19					2517Q
235/35R19		ES79	1038	QV323	1547Q
235/55R19		ES82	1046	QV729	1555Q
245/35R19		ES75	1042	QV339	1550Q
245/40R19		ES75	1042	QV339	1553Q
255/35R19		ES79	1042	QV343	1550Q
255/40R19		ES75	1042	QV343	1555Q
275/35R19		ES80	1046	QV343	1555Q
20" RIMS	275/40R19	ES80	1046	QV729	2319LW
	275/55R19	ES84	1046	QV747	2314LW 2514Q
	285/35R19	ES80	1046	QV343	
	245/35R20	ES75	1042	QV339	1550Q
	245/40R20	ES80	1046	QV343	1555Q
	255/35R20	ES75	1042	QV343	1550Q
	265/35R20	ES75	1046	QV343	1555Q
	275/35R20	ES80	1046	QV729	2319LW



PASSENGER CRUZ CABLES

8.3mm carbon steel rollers over cross cables. Ideal for low clearance vehicles. These cables are an economical alternative to traditional chains . Provides great emergency traction.

PART #	WEIGHT / PAIR
1014	1.8 Kg (4 lbs)
1018	2.7 Kg (6 lbs)
1022	2.7 Kg (6 lbs)
1026	2.3 Kg (5 lbs)
1030	2.7 Kg (6 lbs)
1034	2.7 Kg (6 lbs)
1038	3.2 Kg (7 lbs)
1042	3.6 Kg (8 lbs)
1046	3.6 Kg (8 lbs)

ACCESSORIES

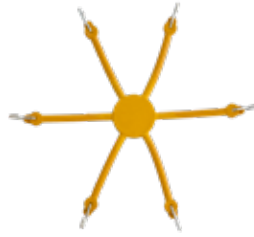

0212

All spider tensioners sold separately



VOLT PREMIUM DIAGONAL CABLES

Premium Passenger Cables. 9.7mm alloy steel rollers over diagonal cross cables. The diagonal pattern ensures the cables maintain continual traction with the road surface offering a smoother ride.

PART #	WEIGHT / PAIR
QV315	4.5 Kg (10 lbs)
QV319	4.5 Kg (10 lbs)
QV323	4.5 Kg (10 lbs)
QV327	4.5 Kg (10 lbs)
QV329	5.0 Kg (11 lbs)
QV331	5.0 Kg (11 lbs)
QV335	5.0 Kg (11 lbs)
QV339	5.0 Kg (11 lbs)
QV343	5.0 Kg (11 lbs)

ACCESSORIES



QV1172

Tensioner included



PASSENGER

NAVIGATOR SQUARE LINK ALLOY

3.7mm cross patterns. European designed chain with square link cross patterns. Ideal for low clearance vehicles. User-friendly tightening system.

PART #	WEIGHT / PAIR
1505Q	3.6 Kg (8 lbs)
1510Q	3.6 Kg (8 lbs)
1515Q	4.1 Kg (9 lbs)
1520Q	4.1 Kg (9 lbs)
1525Q	4.1 Kg (9 lbs)
1530Q	4.1 Kg (9 lbs)
1535Q	4.5 Kg (10 lbs)
1540Q	4.5 Kg (10 lbs)
1545Q	4.5 Kg (10 lbs)
1547Q	4.5 Kg (10 lbs)
1550Q	5.4 Kg (12 lbs)
1553Q	5.4 Kg (12 lbs)
1555Q	5.4 Kg (12 lbs)

ACCESSORIES

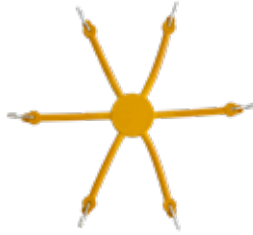

0212

All spider tensioners sold separately



Copy write 2023 QCCANADA

THE ALTERNATIVE TO TRADITIONAL TRACTION!

EASYSOX

LIGHT WEIGHT! LESS BULKY! LOW CLEARANCE!

FOR PASSENGER AND LIGHT TRUCK

LIGHT WEIGHT: EASIER TO HANDLE AND STORE

LOWER RISK: NO METAL OR PLASTIC COMPONENTS THAT CAN STRIKE WHEELS OR CAUSE DAMAGE

LESS BULKY: CAN BE APPLIED TO VEHICLES WITH EXTREMELY LOW CLEARANCE

EASY AS...



LIGHT TRUCK / TRAILER

TIRE SIZE		EASYSOX	CRUZ LT CABLES	VOLT LT PREMIUM DIAGONAL CABLES	NAVIGATOR LT SQUARE LINK ALLOY		PATHFINDER REGULAR TWIST LINK	PATHFINDER SQUARE LINK ALLOY		PATHFINDER CANADIAN SPEC V-BAR		NORDIC™ STUDDED ALLOY	
					3.7MM	5.5MM		SINGLES	TRIPLES	SINGLES	TRIPLES	SINGLES	TRIPLES
		PAGE 6	PAGE 11	PAGE 11	PAGE 12		PAGE 12	PAGE 12		PAGE 13		PAGE 13	
13" RIMS	ST155/80R13	ES81	1014	QV315	1515Q								
	ST165/80R13		1018		1520Q		**1918						
	ST175/80R13	ES77	1022	QV319	1525Q								
	ST185/80R13		1026		1530Q		**1926						
14" RIMS	ST195/75R14	ES79	1030	QV323			2209QC			V245LWQC			
	ST205/75R14	ES79	1034	QV331	1540Q								
	ST215/75R14	ES75	1034 1661	QV335	1545Q		2216QC	2116SLC	4116SLC	V265LWQC			
	27X8.50-14	ES75	1661	QV335			2216QC	2116SLC	4116SLC	V265LWQC			
15" RIMS	7.00-15				2317LW	2517Q				V315	V715	S315	S715
	7.50-15									V315	V715	S315	S715
	8.25-15									V320	V720	S320	S720
	195/70R15C	ES79	1034	QV329	1540Q								
	205/65R15	ES79	1034	QV329	1540Q								
	205/75R15	ES75	1038	QV335	1547Q								
	215/75R15	ES80	1038 1661	QV339	2315LW	2515Q	2216QC	2116SLC	4116SLC	V265LWQC			
	225/70R15	ES75	1038 1661	QV343	2315LW	2515Q	2216QC	2116SLC	4116SLC	V265LWQC			
	225/75R15	ES80	1042	QV343	2315LW	2515Q	2216QC	2116SLC	4116SLC	V265LWQC			
	235/70R15	ES83	1042 1661	QV343 QV729	2317LW	2517Q	2216QC	2116SLC	4116SLC	V265LWQC			
	235/75R15	ES82	1042 1665	QV343 QV729	2317LW	2517Q	2219QC	2119SLC	4119SLC	V265LWQC			
	255/70R15	ES83	1046 1661	QV735	2319LW	2519Q	2229QC	2129SLC	4129SLC	V315LWQC			
	265/70R15	ES83	1665	QV735	2319LW	2519Q	2221QC	2121SLC	4121SLC	V275LWQC			
	265/75R15	ES83	1669	QV741	2319LW	2519Q	2221QC	2121SLC	4121SLC	V315	V715	S315	S715
	275/60R15	ES83	1046 1661	QV729	2319LW	2519Q	2229QC	2129SLC	4129SLC	V315LWQC			
	27X9.50R15LT	ES75	1661	QV339			2229QC						
	30X9.50R15LT	ES83	1669	QV735			2229QC	2129SLC		V315		S315	
	31X10.50R15LT	ES84	1669	QV741	2319LW	2519Q	3227QC*	3127SLC*		V315	V715	S315	S715
	32X11.50R15LT	ES84	1675	QV747	2314LW	2514Q	3229QC*	3129SLC*		V320	V720	S320	S720
	33X10.50R15LT		1669	QV747			3229QC*	3129SLC*		V320	V720	S320	S720
33X12.50R15LT	ES188	1675	QV757	2335LW	2536Q	3235QC*	3129SLC*		V295		S295		
35X12.50R15LT	ES195	1681	QV761 QV853				3135SLC*		V296		S296		
35X13.50R15LT	ES199		QV761 QV853				3135SLC*		V298		S298		
16" RIMS	7.50-16		1669	QV741	2319LW	2519Q	2221QC	2121SLC	4121SLC	V315	V715	S315	S715
	9.00-16						3259QC*			V332	V732	S332	S732
	195/75R16C	ES80	1038	QV339		1547Q							
	205/75R16C	ES80	1661	QV343			2216QC	2116SLC	4116SLC	V265LWQC			
	215/70R16	ES80	1038 1661	QV343	2315LW	2515Q	2216QC	2116SLC	4116SLC	V265LWQC			
	215/75R16	ES82	1042 1665	QV343 QV729	2315LW	2515Q	2216QC	2116SLC	4116SLC	V265LWQC			
	215/85R16	ES83	1665	QV729	2319LW	2519Q	2219QC	2119SLC	4119SLC	V315	V715	S315	S715
	225/50R16	ES78	1034	QV335	1545Q		2209QC			V245LWQC			
	225/70R16	ES82	1042 1661	QV343	2317LW	2517Q	2219QC	2119SLC	4119SLC	V265LWQC			
	225/75R16	ES82	1042 1665	QV343 QV729		2517Q	2219QC	2119SLC	4119SLC	V315	V715	S315	S715
	235/60R16	ES75	1042	QV339	1553Q		2211QC			V245LWQC			
	235/65R16C	ES80	1042 1665	QV343 QV729			2227QC	2127SLC	4127SLC	V315LWQC			
	235/70R16	ES82	1665	QV729	2319LW	2519Q	2229QC	2129SLC	4129SLC	V315	V715	S315	S715
	235/75R16	ES83	1665	QV735	2319LW	2519Q	2219QC	2119SLC	4119SLC	V315	V715	S315	S715

*Wide-Base

LIGHT TRUCK / TRAILER

TIRE SIZE	EASYSOX	CRUZ LT CABLES	VOLT LT PREMIUM DIAGONAL CABLES	NAVIGATOR LT SQUARE LINK ALLOY		PATHFINDER REGULAR TWIST LINK	PATHFINDER SQUARE LINK ALLOY		PATHFINDER CANADIAN SPEC V-BAR		NORDIC™ STUDDED ALLOY		
				3.7MM	5.5MM		SINGLES	TRIPLES	SINGLES	TRIPLES	SINGLES	TRIPLES	
	PAGE 6	PAGE 11	PAGE 11	PAGE 12		PAGE 12	PAGE 12		PAGE 13		PAGE 13		
16" & 16.5" RIMS	ST235/80R16	ES83	1669	QV741	2319LW	2519Q	2219QC	2119SLC	4119SLC	V320	V720	S320	S720
	235/85R16	ES84	1669	QV741	2321LW	2521Q	2221QC	2121SLC	4121SLC	V320	V720	S320	S720
	245/70R16	ES83	1669	QV735	2319LW	2519Q	2229QC	2129SLC	4129SLC	V315	V715	S315	S715
	245/75R16	ES83	1669	QV741	2329LW	2529Q	2221QC	2121SLC	4121SLC	V315	V715	S315	S715
	255/65R16	ES82	1042 1665	QV735	2319LW	2519Q	2229QC	2129SLC	4129SLC	V315	V715	S315	S715
	255/70R16	ES83	1669	QV735	2319LW	2519Q	2221QC	2121SLC	4121SLC	V275LWQC			
	255/85R16	ES85	1675	QV751	2314LW	2514Q	2228QC	2128SLC	4128SLC	V322	V722	S322	S722
	265/70R16	ES83	1663	QV741	2329LW	2529Q	2228QC	2128SLC	4128SLC	V315	V715	S315	S715
	265/75R16	ES84	1675	QV747	2328LW	2521Q	2228QC	2128SLC	4128SLC	V320	V720	S320	S720
	275/70R16	ES84	1675	QV747	2321LW	2521Q	3228QC*			V320	V720	S320	S720
	285/70R16	ES84	1675	QV751			3229QC*	3129SLC*		V320	V720	S320	S720
	285/75R16	ES85	1680	QV751	2314LW	2514Q	2238QC	2138SLC	4138SLC	V295		S295	
	295/75R16	ES85		QV757	2314LW	2514Q	3231QC	3131SLC*		V296		S296	
	305/70R16	ES85		QV757	2335LW	2536Q	2238QC	2138SLC	4138SLC	V295		S295	
	315/75R16	ES195	2314	QV761 QV853	2337LW	2536Q				V296		S296	
	10-16.5		1661	QV735			3210QC*			V320	V720	S320	S720
	12-16.5		1669	QV751	2319LW	2519Q	3227QC*	3127SLC*		V295		S295	
	8.75-16.5		1669	QV729			3210QC*			V315	V715		
	9.50-16.5		1675	QV735	2327LW	2527Q	3229QC*	2121SLC	4121SLC	V315	V715	S315	S715
17" RIMS	225/65R17	ES82	1042 1665	QV343	2317LW	2517Q							
	225/75R17	ES83	1669	QV729	2319LW	2519Q	2219QC	2119SLC	4119SLC	V315	V715	S315	S715
	235/55R17	ES75	1042 1661	QV343	2315LW								
	235/60R17	ES80	1042 1665	QV343	2317LW		2227QC	2127SLC	4127SLC	V315	V715	S315	S715
	235/65R17	ES82	1046 1665	QV729	2319LW	2519Q	2211QC			V315	V715	S315	S715
	235/70R17	ES83	1665	QV735	2319LW	2519Q	2219QC	2119SLC	4119SLC	V315	V715	S315	S715
	235/75R17	ES83	1675	QV735	2321LW	2521Q	2227QC	2127SLC	4127SLC	V315	V715	S315	S715
	235/80R17	ES84	1669	QV747	2319LW	2519Q	2221QC	2121SLC	4121SLC	V315	V715	S315	S715
	245/60R17	ES83	1665	QV729	2317LW	2517Q	2229QC	2129SLC	4129SLC	V315	V715	S315	S715
	245/65R17	ES83	1046 1669	QV735	2319LW	2519Q	2227QC	2127SLC	4127SLC	V315	V715	S315	S715
	245/70R17	ES83	1663	QV735	2319LW	2519Q	2227QC	2127SLC	4127SLC	V315	V715	S315	S715
	245/75R17	ES84	1675	QV741		2521Q	2228QC	2128SLC	4128SLC	V315	V315	S315	S715
	255/55R17	ES83	1665	QV729	2317LW	2517Q	2219QC	2119SLC	4119SLC	V315	V715	S315	S715
	255/60R17	ES83	1673	QV735	2319LW	2519Q	2227QC	2127SLC	4127SLC	V315	V715	S315	S715
	255/65R17	ES83	1663	QV735	2319LW	2519Q	2228QC	2128SLC	4128SLC	V320	V720	S320	S720
	255/70R17	ES84	1675	QV747	2321LW	2521Q	2228QC	2128SLC	4128SLC	V320	V720	S320	S720
	255/75R17	ES84	1663	QV751	2327LW	2527Q	2228QC	2128SLC	4128SLC	V320	V720	S320	S720
	265/60R17		1673	QV735	2319LW	2519Q				V320	V720	S320	S720
	265/65R17	ES83	1663	QV741	2321LW	2521Q	2227QC	2127SLC	4127SLC	V320	V720	S320	S720
	265/70R17	ES84	1675	QV747	2327LW	2521Q	2228QC	2128SLC	4128SLC	V320	V720	S320	S720
	275/55R17		1673	QV741	2319LW	2519Q	2227QC	2127SLC	4127SLC	V320	V720	S320	S720
	275/60R17	ES83	1675	QV741	2327LW	2527Q	3227QC*	3127SLC*		V320	V720	S320	S720
	275/65R17	ES84	1675	QV747	2321LW	2521Q	2228QC	2128SLC	4128SLC	V320	V720	S320	S720
	275/70R17	ES85	1675	QV751	2321LW	2521Q	2228QC	2128SLC	4128SLC	V322	V722	S322	S722
285/70R17	ES85	1678	QV753	2328LW	2533Q	2238QC	2138SLC	4138SLC	V295		S295		
285/75R17	ES188	1680	QV757			3229QC*	3129SLC*		V295		S295		

*Wide Base

LIGHT TRUCK / TRAILER

TIRE SIZE	EASYSOX	CRUZ LT CABLES	VOLT LT PREMIUM DIAGONAL CABLES	NAVIGATOR LT SQUARE LINK ALLOY		PATHFINDER REGULAR TWIST LINK	PATHFINDER SQUARE LINK ALLOY		PATHFINDER CANADIAN SPEC V-BAR		NORDIC™ STUDDED ALLOY	
				3.7MM	5.5MM		SINGLES	TRIPLES	SINGLES	TRIPLES	SINGLES	TRIPLES
	PAGE 6	PAGE 11	PAGE 11	PAGE 12		PAGE 12	PAGE 12		PAGE 13		PAGE 13	
17 & 17.5" RIMS	295/70R17	ES188	1678	QV841	2337LW	2536Q				V295		S295
	305/65R17		1680	QV751	2335LW	2536Q	3229QC*	3129SLC*		V295		S295
	305/70R17	ES85	1678	QV761 QV853		2536Q	3231QC*	3131SLC*		V296		S296
	315/70R17	ES195	2314	QV761 QV853	2337LW	2536Q				V332	V732	S332 S372
	33X12.50R17LT	ES188	1678	QV757			2238QC	2138SLC	4138SLC	V295		S295
	35X12.50R17LT	ES195	1681	QV761 QV853	2337LW	2537Q	3231QC*	3131SLC*		V296		S296
	37X12.50R17LT	ES199	2314	QV859			3235QC*	3135SLC*		V298		S298
	37X13.50R17LT	ES199		QV869			3251QC*			V298		S298
	215/75R17.5	ES83	1673	QV729	2319LW	2519Q	2229QC	2129SLC	4129SLC	V315	V715	S315 S715
	245/70R17.5	ES83	1675	QV741	2321LW	2521Q	2228QC	2128SLC	4128SLC	V320	V720	S320 S720
18" RIMS	225/55R18	ES80	1042	QV339 QV729	2317LW	2517Q	2229QC	2129SLC	4129SLC			
	235/55R18	ES80	1046 1673	QV729	2317LW	2517Q	2229QC	2129SLC	4129SLC			
	235/60R18	ES82	1046 1669	QV729	2319LW	2519Q	2229QC	2129SLC	4129SLC	V320	V720	S320 S720
	235/65R18	ES83	1673	QV735	2319LW	2519Q	2229QC	2129SLC	4129SLC	V320	V720	S320 S720
	245/55R18	ES83	1673	QV735	2319LW	2519Q	2229QC	2129SLC	4129SLC			
	245/60R18	ES83	1673	QV735	2319LW	2519Q	2229QC	2129SLC	4129SLC	V320	V720	S320 S720
	255/55R18	ES82	1046 1673	QV735	2319LW	2519Q	2229QC	2129SLC	4129SLC	V320	V720	S320 S720
	255/60R18	ES83	1675	QV741	2321LW	2521Q	2227QC	2127SLC	4127SLC	V320	V720	S320 S720
	255/65R18	ES84	1675	QV747	2321LW	2521Q	2229QC	2129SLC	4129SLC	V320	V720	S320 S720
	255/70R18	ES84		QV747	2327LW	2527Q	2228QC	2128SLC	4128SLC	V320	V720	S320 S720
	265/60R18	ES83	1675	QV741	2321LW	2521Q	2228QC	2128SLC	4128SLC	V320	V720	S320 S720
	265/65R18	ES84	1663	QV747	2327LW	2527Q	2228QC	2128SLC	4128SLC	V320	V720	S320 S720
	265/70R18	ES85	1678	QV751	2328LW	2533Q	2228QC	2128SLC	4128SLC	V322	V722	S322 S722
	275/60R18	ES84	1675	QV747	2321LW	2521Q	2228QC	2128SLC	4128SLC	V320	V720	S320 S720
	275/65R18	ES84	1675	QV751	2328LW	2533Q	2228QC	2128SLC	4128SLC	V320	V720	S320 S720
	275/70R18	ES85	1680	QV753		2533Q	3231QC*	3131SLC*		V322	V722	S322 S722
	285/50R18	ES83	1675	QV735	2329LW	2529Q	2228QC	2128SLC	4128SLC			
	285/55R18		1679	QV747	2327LW	2527Q	2227QC	2127SLC	4127SLC	V295		S295
	285/60R18	ES84	1675	QV751	2327LW	2527Q	2228QC	2128SLC	4128SLC	V295		S295
	285/65R18	ES85	1678	QV751	2328LW	2533Q				V295		S295
	285/70R18	ES85	1681	QV757						V295		S295
	285/75R18	ES195		QV761		2536Q				V296		S296
	295/45R18	ES83	1673	QV735	2329LW	2529Q	2227QC	2127SLC	4127SLC			
	295/70R18	ES195		QV835						V296		S296
	305/60R18	ES85	1681	QV753 QV841		2536Q				V296		S296
	305/65R18	ES188								V296		S296
	305/70R18	ES195	2314	QV859		2539Q				V296		S296
	325/60R18	ES85		QV753 QV853		2536Q				V296		S296
325/65R18	ES199		QV761 QV853						V298		S298	
35X12.50R18LT	ES195	1681	QV761 QV853			3231QC*	3131SLC*		V296		S296	
37X13.50R18LT	ES199		QV869			3251QC*			V298		S298	
38X15.50R18LT			QV881									
19" RIMS	235/55R19	ES82	1046	QV729		1555Q	2219QC					
	245/55R19	ES83	1669	QV735	2319LW	2519Q						
	255/50R19	ES82	1669	QV735	2329LW	2529Q	2227QC	2127SLC	4127SLC			

* Wide Base

LIGHT TRUCK / TRAILER

TIRE SIZE	EASYSOX	CRUZ LT CABLES	VOLT LT PREMIUM DIAGONAL CABLES	NAVIGATOR LT SQUARE LINK ALLOY		PATHFINDER REGULAR TWIST LINK	PATHFINDER SQUARE LINK ALLOY		PATHFINDER CANADIAN SPEC V-BAR		NORDIC™ STUDDED ALLOY		
				3.7MM	5.5MM		SINGLES	TRIPLES	SINGLES	TRIPLES	SINGLES	TRIPLES	
	PAGE 6	PAGE 11	PAGE 11	PAGE 12		PAGE 12	PAGE 12		PAGE 13		PAGE 13		
19" RIMS	255/55R19	ES83	1663	QV735	2319LW	2521Q	2227QC	2127SLC	4127SLC				
	275/45R19	ES83	1673	QV741	2319LW	2519Q	2229QC	2129SLC	4129SLC	V322	V722	S322	S722
	275/55R19	ES84	1046 1679	QV747	2314LW	2514Q	2228QC	2128SLC	4128SLC				
	285/45R19	ES83	1663	QV735	2329LW	2529Q	2227QC	2127SLC	4127SLC	V322	V722	S322	S722
20" RIMS	245/45R20	ES82	1669	QV729	2319LW	2519Q	2229QC	2129SLC	4129SLC	V295		S295	
	245/50R20	ES83	1669	QV735	2321LW	2521Q	2227QC	2127SLC	4127SLC				
	255/45R20	ES82	1669	QV729	2319LW	2519Q	2229QC	2129SLC	4129SLC				
	265/45R20	ES83	1673	QV735	2319LW	2519Q	2227QC	2127SLC	4127SLC				
	265/50R20	ES83	1675	QV747	2327LW	2527Q	3227QC	2128SLC	4128SLC				
	265/60R20	ES84		QV751		2533Q	2238QC	2138SLC	4138SLC	V295		S295	
	275/45R20	ES83	1675	QV741	2321LW	2521Q	2228QC	2128SLC	4128SLC	V298		S298	
	275/50R20	ES84		QV747		2527Q	2228QC	2128SLC		V320		S320	
	275/55R20	ES85	1679	QV751	2328LW	2533Q	2238QC	2138SLC	4138SLC	V295		S295	
	275/60R20	ES188	1678	QV751			2238QC	2138SLC	4138SLC	V295		S295	
	275/65R20	ES195		QV757	2335LW		2238QC	2138SLC	4138SLC	V295		S295	
	285/50R20	ES84	1679	QV751	2328LW	2533Q	3228QC*	2128SLC		V295		S295	
	285/60R20	ES85		QV757		2536Q				V296		S296	
	295/45R20	ES84	1679	QV747	2327LW	2527Q	2228QC	2128SLC	4128SLC				
	305/50R20	ES85	1681	QV761	2328LW	2536Q	2238QC	2138SLC	4138SLC	V295		S295	
	305/55R20	ES188		QV853			3231QC*	3131SLC*		V298		S298	
	325/60R20	ES199		QV865		2539Q				V298		S298	
	33X12.50R20LT	ES188	1680	QV757			3231QC*	3131SLC*		V295		S295	
	35X12.50R20LT	ES195		QV761 QV853			3231QC*	3131SLC*		V296		S296	
22+" RIMS	265/35R22	ES83	1673	QV741									
	265/40R22	ES83	1663	QV741	2321LW	2521Q	2227QC	2127SLC	4127SLC				
	275/45R22		1679	QV747	2314LW	2514Q							
	285/35R22	ES83	1675	QV747	2327LW	2527Q	2228QC	2128SLC	4128SLC				
	295/30R22	ES83	1675	QV735									
	305/40R22	ES84	1681	QV751	2327LW	2527Q	2238QC	2138SLC	4138SLC				
	305/45R22	ES85	1680	QV757			2238QC	2138SLC	4138SLC				
	325/50R22	ES199	2315										
	295/40R24	ES188	1681	QV761	2337LW								

* Wide Base



LIGHT TRUCK / TRAILER

CRUZ LT CABLES

10.2mm metal rollers over cross cable. Ideal for low clearance vehicles. These cables are an economical alternative to traditional chains. Provides great emergency traction.

PART #	WEIGHT / PAIR
1661	4.5 Kg (10 lbs)
1663	5.4 Kg (12 lbs)
1665	5.0 Kg (11 lbs)
1669	5.4 Kg (12 lbs)
1673	5.0 Kg (11 lbs)
1675	6.0 Kg (13 lbs)
1678	6.4 Kg (14 lbs)
1679	6.8 Kg (15 lbs)
1680	6.8 Kg (15 lbs)
1681	6.8 Kg (15 lbs)

ACCESSORIES



#0216

All spider tensioners sold separately



VOLT LT PREMIUM DIAGONAL CABLES

Premium Light Truck Cables. 10.7mm alloy steel rollers over diagonal cross cables. The diagonal pattern ensures the cables maintain continual traction with the road surface offering a smoother ride.

PART #	WEIGHT / PAIR
QV729	5.9 Kg (13 lbs)
QV735	5.9 Kg (13 lbs)
QV741	6.3 Kg (14 lbs)
QV747	6.8 Kg (15 lbs)
QV751	6.8 Kg (15 lbs)
QV753	7.3 Kg (16 lbs)
QV757	7.7 Kg (17 lbs)
QV761	8.6 Kg (19 lbs)

ACCESSORIES



#QV1174

Tensioner included



NAVIGATOR LT SQUARE LINK ALLOY

3.7mm lightweight (LW) & 5.5mm standard alloy square link cross patterns. European design with user friendly tightening system. Excellent continual traction.

PART #	WEIGHT / PAIR	PART #	WEIGHT / PAIR
3.7mm Lightweight		5.5mm Standard	
2314LW	9.5 Kg (21 lbs)	2514Q	10.4 Kg (23 lbs)
2315LW	7.7 Kg (17 lbs)	2515Q	8.6 Kg (19 lbs)
2317LW	7.3 Kg (16 lbs)	2517Q	7.7 Kg (17 lbs)
2319LW	8.6 Kg (19 lbs)	2519Q	9.1 Kg (20 lbs)
2321LW	8.6 Kg (19 lbs)	2521Q	9.1 Kg (20 lbs)
2327LW	10 Kg (22 lbs)	2527Q	10.9 Kg (24 lbs)
2328LW	6.8 Kg (15 lbs)	2529Q	9.5 Kg (21 lbs)
2329LW	9.1 Kg (20 lbs)	2533Q	12.2 Kg (27 lbs)
2335LW	7.3 Kg (16 lbs)	2536Q	13.2 Kg (29 lbs)
2337LW	7.3 Kg (16 lbs)	2539Q	14.5 Kg (32 lbs)

ACCESSORIES

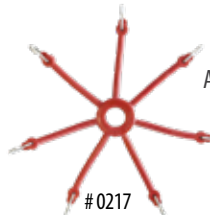

#0217

All spider tensioners sold separately



Copyright © 2013 QCCANAD

LIGHT TRUCK / TRAILER

PATHFINDER REGULAR TWIST LINK

5.5mm cross chains, Alloy steel highway chains. NOT for use on plows, forklifts or tow trucks. Includes cam locks (QC).

PART #	WEIGHT / PAIR	CROSS CHAIN
2214QC	13 Kg (28 lbs)	6221
2216QC	10 Kg (22 lbs)	6221
2219QC	11 Kg (24 lbs)	6221
2221QC	11 Kg (25 lbs)	6221
2227QC	12 Kg (26 lbs)	6225
2228QC	13 Kg (28 lbs)	6225
2229QC	11 Kg (25 lbs)	6225
2238QC	19 Kg (41 lbs)	6253



ACCESSORIES

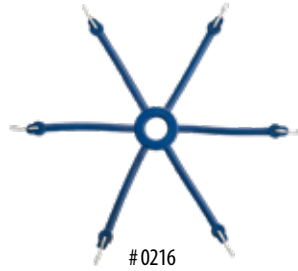

All spider tensioners sold separately



PATHFINDER SQUARE LINK ALLOY

5.5mm (SL), 7mm*, and 8mm (HDSL) cross chains. Alloy steel for extra durability and longer wear. Reversible for extra long life. Square edge links dig into the driving surface providing excellent traction. Available with and without cam locks (C).

PART #	WEIGHT / PAIR	PART #	WEIGHT / PAIR	CROSS CHAIN
SINGLES		TRIPLES		
2114SLC	14 Kg (30 lbs)	4114SLC	29 Kg (64 lbs)	6221SL
2116SLC	12 Kg (27 lbs)	4116SLC	24 Kg (53 lbs)	6221SL
2119SLC	12 Kg (26 lbs)	4119SLC	27 Kg (59 lbs)	6221SL
2121SLC	13 Kg (28 lbs)	4121SLC	29 Kg (64 lbs)	6221SL
2127SLC	15 Kg (32 lbs)	4127SLC	31 Kg (68 lbs)	6225SL
2128SLC	13 Kg (29 lbs)	4128SLC	31 Kg (68 lbs)	6225SL
2129SLC	12 Kg (26 lbs)	4129SLC	25 Kg (56 lbs)	6225SL
2137SLC*	21 Kg (47 lbs)	4137SLC*	44 Kg (97 lbs)	6251SL
2138SLC*	20 Kg (45 lbs)	4138SLC*	41 Kg (90 lbs)	6251SL
2139SLC*	28 Kg (61 lbs)	4139SLC*	53 Kg (116 lbs)	6251SL



ACCESSORIES

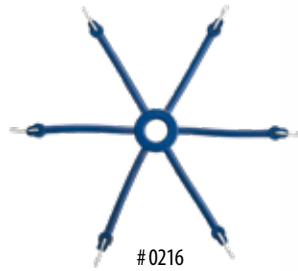

All spider tensioners sold separately



Available with Cam Locks (C)



LIGHT TRUCK / TRAILER

PATHFINDER CANADIAN SPEC V-BAR

7mm & 8mm* cross chains. Alloy steel V-Bar reinforced. Excellent traction for extreme weather conditions and some off-road applications. Extra heavy side chain & cross chain hooks for durability. Ensure your vehicle has the clearance for these chains prior to using them.

SINGLES		CROSS CHAIN
PART #	WEIGHT / PAIR	
V295	21 Kg (47 lbs)	V5340
V296	23 Kg (50 lbs)	V5340
V298*	24 Kg (52 lbs)	V5355
V315	19 Kg (52lbs)	V5315
V320	21 Kg (47 lbs)	V5315
V322	24 Kg (52 lbs)	V5315
V332	25 Kg (55 lbs)	V5330

TRIPLES		CROSS CHAIN
PART #	WEIGHT / PAIR	
V715	36 Kg (80 lbs)	V5315
V720	40 Kg (89 lbs)	V5315
V722	44 Kg (98 lbs)	V5315
V732	45 Kg (100 lbs)	V5330



ACCESSORIES



All spider tensioners sold separately



Available with Cam Locks (QC)

Also available in lightweight 6mm alloy steel (LW).
70% the weight of standard V-bar, increasing ease of installation. Call for details.



NORDIC™ STUDED ALLOY

7mm & 8mm* cross chains. Hardened alloy cross chains for extra durability and strength. Ideal for aggressive off-road applications & harsh weather conditions. Studs dig into driving surface for excellent traction. Test fit to ensure your vehicle has the clearance for these chains prior to using them.

SINGLES		CROSS CHAIN
PART #	WEIGHT / PAIR	
S295	23 Kg (49 lbs)	6915
S296	24 Kg (52 lbs)	6915
S298*	25 Kg (54 lbs)	6926
S315	20 Kg (45 lbs)	6912
S320	23 Kg (51 lbs)	6912
S322	25 Kg (54 lbs)	6912
S332	26 Kg (57 lbs)	6913

TRIPLES		CROSS CHAIN
PART #	WEIGHT / PAIR	
S715	35 Kg (77 lbs)	6912
S720	38 Kg (84 lbs)	6913
S722	42 Kg (93 lbs)	6912
S732	45 Kg (100 lbs)	6913



ACCESSORIES



All spider tensioners sold separately



Available with Cam Locks (QC)

Also available with lightweight 6mm alloy side chain (LW), to increase ease of installation. Call for details.



COMMERCIAL TRUCK / TRAILER / BUS

TIRE SIZE	EASYSOX	CRUZ TR CABLES		VOLT TRUCK PREMIUM DIAGONAL CABLES	PATHFINDER REGULAR TWIST LINK		PATHFINDER SQUARE LINK ALLOY		PATHFINDER CAN-TRAC WEAR-BAR SQUARE LINK		PATHFINDER CANADIAN SPEC V-BAR		NORDIC™ STUDDED ALLOY		SKYDD LIGHTWEIGHT STUDDED ALLOY			
		SINGLES	TRIPLES		SINGLES	TRIPLES	SINGLES	TRIPLES	SINGLES	TRIPLES	SINGLES	TRIPLES	SINGLES	TRIPLES	SINGLES	TRIPLES	SINGLES	TRIPLES
		PAGE 16	PAGE 17		PAGE 17	PAGE 18	PAGE 19	PAGE 20	PAGE 21 & 22	PAGE 23 & 24	PAGE 25							
15" - 19.5" RIMS	9.00-15		2314	4314	QV837	2237QC	4237QC	2137SLC	4137SLC			V322	V722	S322QC	S722QC	SK322	SK722	
	8.25-16									QCC-515WB-007*								
	10R17.5				QV841							V315	V715	S315QC	S715QC	SK315	SK715	
	235/75R17.5	ES84	1665		QV741	2228QC	4228QC	2128SLC	4128SLC			V320	V720	S320QC	S720QC	SK320	SK720	
	8R19.5		1663		QV747	2214QC	4214QC	2114SLC	4114SLC			V320	V720	S320QC	S720QC	SK320	SK720	
	16.5-19.5		3055			3255QC		2149SLC										
	18-19.5		3057			3257QC												
	225/70R19.5	ES85	1663		QV747	2214QC	4214QC	2114SLC	4114SLC			V315	V715	S315QC	S715QC	SK315	SK715	
	245/70R19.5	ES188	1675		QV751 QV835	2228QC	4228QC	2128SLC	4128SLC			V322	V722	S322QC	S722QC	SK322	SK722	
	265/70R19.5	ES188	2314	4314	QV757 QV837	2237QC	4237QC	2137SLC	4137SLC			V322	V722	S322QC	S722QC	SK322	SK722	
	285/70R19.5	ES195	2315	4315	QV853	2246QC	4246QC	2146SLC	4146SLC			V342	V742	S342QC	S742QC	SK342	SK742	
	305/70R19.5	ES199				2239QC	4239QC	2139SLC	4139SLC			V342	V742	S342QC	S742QC	SK342	SK742	
	445/65R19.5				QV896							V379	V779	S379QC	S779QC	SK379	SK779	
20" RIMS	7.00-20		1663			2233QC	4233QC	2133SLC	4133SLC			V322	V722	S322QC	S722QC	SK322	SK722	
	7.50-20	ES199	2314	4314		2237QC	4237QC	2137SLC	4137SLC			V322	V722	S322QC	S722QC	SK322	SK722	
	8.25-20	ES205	2314	4314	QV859	2239QC	4239QC	2139SLC	4139SLC			V332	V732	S332QC	S732QC	SK332	SK732	
	9.00-20	ES205	2315	4315	QV869	2241QC	4241QC	2141SLC	4141SLC			V342	V742	S342QC	S742QC	SK342	SK742	
	10.00-20	ES225	2316	4316	QV881	2247QC	4247QC	2147SLC	4147SLC	CT343QC	CT743QC	V343	V743	S343QC	S743QC	SK343	SK743	
	11.00-20	ES245	2317	4317	QV887	2255QC	4255QC	2155SLC	4155SLC	CT355QC	CT755QC	V355	V755	S355QC	S755QC	SK355	SK755	
	12.5R20					1504		1504HDSLS				1504V		1504SQC		1504S		
	14.00R20											V382	V782	S382QC	S782QC	SK382	SK782	
	16.00R20									QCC-522WB-007*				2924A-10		2924A-10		
	14/80R20				QV892	2257QC	4257QC	2157SLC	4157SLC									
	14.75/80R20											V377	V777	S377QC	S777QC	S377	S777	
	335/80R20					1504		1504HDSLS				1504V		1504SQC		1504S		
	365/80R20		3055		QV892	3255QC		3155SLC										
395/85R20				QV898					QCC-520WB-007*									
22" - 22.5" RIMS	10.00-22		2317	4317	QV887	2249QC	4249QC	2149SLC	4149SLC	CT344QC	CT744QC	V344	V744	S344QC	S744QC	SK344	SK744	
	11.00-22		2317	4317	QV891	2256QC	4256QC	2156SLC	4156SLC			V356	V756	S356QC	S756QC	SK356	SK756	
	7.00-22.5		1663		QV751	2233QC	4233QC	2133SLC	4133SLC			V320	V720	S320QC	S720QC	SK320	SK720	
	8.00-22.5					2137QC	4237QC	2137SLC	4137SLC			V322	V722	S322QC	S722QC	SK322	SK722	
	9.00-22.5	ES205	2314	4314	QV859	2239QC	4239QC	2139SLC	4139SLC			V332	V732	S332QC	S732QC	SK332	SK732	
	10R22.5	ES205	2315	4315	QV869	2241QC	4241QC	2141SLC	4141SLC			V342	V742	S342QC	S742QC	SK342	SK742	
	11R22.5	ES225	2316	4316	QV881	2247QC	4247QC	2147SLC	4147SLC	CT343QC	CT743QC	V343	V743	S343QC	S743QC	SK343	SK743	
	12R22.5	ES245	2317	4317	QV887	2255QC	4255QC	2155SLC	4155SLC	CT355QC	CT755QC	V355	V755	S355QC	S755QC	SK355	SK755	
	225/70R22.5		1669			2233QC	4233QC	2133SLC	4133SLC			V332	V732	S332QC	S732QC	SK332	SK732	
	235/80R22.5	ES199	2314	4314	QV859	2239QC	4239QC	2139SLC	4139SLC			V332	V732	S332QC	S732QC	SK332	SK732	
	245/75R22.5	ES199	2314	4314	QV859	2241QC	4241QC	2141SLC	4141SLC			V332	V732	S332QC	S732QC	SK332	SK732	
	255/70R22.5	ES199	2314	4314	QV859	2239QC	4239QC	2139SLC	4139SLC			V332	V732	S332QC	S732QC	SK332	SK732	
	255/80R22.5	ES205	2315	4315	QV865	2241QC	4241QC	2141SLC	4141SLC			V342	V742	S342QC	S742QC	SK342	SK742	
	265/75R22.5	ES205	2314	4314	QV865	2241QC	4241QC	2141SLC	4141SLC			V342	V742	S342QC	S742QC	SK342	SK742	
	275/70R22.5	ES199	2314	4314	QV869	2241QC	4241QC	2141SLC	4141SLC			V342	V742	S342QC	S742QC	SK342	SK742	
	275/80R22.5	ES205	2316	4316	QV881	2247QC	4247QC	2147SLC	4147SLC	CT343QC	CT743QC	V343	V743	S343QC	S743QC	SK343	SK743	
285/75R22.5	ES205	2316	4316	QV887	2247QC	4247QC	2147SLC	4147SLC	CT343QC	CT743QC	V343	V743	S343QC	S743QC	SK343	SK743		
295/75R22.5	ES205	2316	4316	QV887	2247QC	4247QC	2147SLC	4147SLC			V343	V743	S343QC	S743QC	SK343	SK743		

* Military Grade Wear-Bar Pattern - See page 26

COMMERCIAL TRUCK / TRAILER / BUS

TIRE SIZE	EASYSOX	CRUZ TR CABLES		VOLT TRUCK PREMIUM DIAGONAL CABLES	PATHFINDER REGULAR TWIST LINK		PATHFINDER SQUARE LINK ALLOY		PATHFINDER CAN-TRAC WEAR-BAR SQUARE LINK		PATHFINDER CANADIAN SPEC V-BAR		NORDIC™ STUDDED ALLOY		SKYDD LIGHTWEIGHT STUDDED ALLOY		
		SINGLES	TRIPLES		SINGLES	TRIPLES	SINGLES	TRIPLES	SINGLES	TRIPLES	SINGLES	TRIPLES	SINGLES	TRIPLES	SINGLES	TRIPLES	
		PAGE 16	PAGE 17		PAGE 17	PAGE 18		PAGE 19		PAGE 20		PAGE 21 & 22		PAGE 23 & 24		PAGE 25	
22.5" RIMS	295/80R22.5	ES225	2317	4317	QV881	2251QC	4251QC	2151SLC	4151SLC	CT343QC	CT743QC	V343	V743	S343QC	S743QC	SK343	SK743
	315/80R22.5	ES245	2317	4317	QV892	2255QC	4255QC	2155SLC	4155SLC	CT355QC	CT755QC	V355	V755	S356QC	S756QC	SK356	SK756
	365/70R22.5		3055		QV892							V356	V756	S356QC	S756QC	SK356	SK756
	385/65R22.5	ES385	3055		QV892	3255QC		3155SLC				V372	V772	S372QC	S772QC	SK372	SK772
	425/65R22.5		3071		QV896	3271QC		3171SLC				V377	V777	S377QC	S777QC	SK377	SK777
	445/50R22.5	ES445	3069		QV897	3269QC						V375		S375QC		SK375	
	445/65R22.5		3061		QV818	3261QC		3161SLC				V382	V782	S382QC	S782QC	SK382	SK782
	455/55R22.5	ES455	3071		QV899	3271QC						V377	V777	S377QC	S777QC	SK377	SK777
	495/45R22.5	CALL FOR ASSISTANCE															
24" - 25" RIMS	11.00R24		2317	4317		2256QC	4256QC	2156SLC	4156SLC			V356	V756	S356QC	S756QC	SK356	SK756
	12.00R24		2317	4317	QV899	2257QC	4257QC	2157SLC	4157SLC			V379	V779	S379QC	S779QC	SK379	SK779
	14.00R24													S387QC	S787QC	SK387	SK787
	11R24.5	ES245	2317	4317	QV887	2249QC	4249QC	2149SLC	4149SLC	CT344QC	CT744QC	V344	V744	S344QC	S744QC	SK344	SK744
	12R24.5		2317	4317		2256QC	4256QC	2156SLC	4156SLC			V356	V756	S356QC	S756QC	SK356	SK756
	275/80R24.5	ES225	2316	4316	QV877	2247QC	4247QC	2147SLC	4147SLC	CT344QC	CT744QC	V344	V744	S344QC	S744QC	SK344	SK744
	285/75R24.5	ES225	2316	4316	QV881	2249QC	4249QC	2149SLC	4149SLC	CT344QC	CT744QC	V344	V744	S344QC	S744QC	SK344	SK744
	305/75R24.5		2317	4317	QV887	2255QC	4255QC	2155SLC	4155SLC	CT344QC	CT744QC	V344	V744	S344QC	S744QC	SK344	SK744
	14.00R25													S387QC		SK387	



Copyright 2023 QCCANADA

THE ALTERNATIVE TO TRADITIONAL TRACTION!

EASYSOX

LIGHT WEIGHT! LESS BULKY! LOW CLEARANCE!

QUICK AND EASY TO INSTALL!

LIGHT WEIGHT: EASIER TO HANDLE AND STORE

LESS BULKY: CAN BE APPLIED TO VEHICLES WITH EXTREMELY LOW CLEARANCE. SAFE TO USE WITH FAIRINGS, COWLINGS OR AIR DEFLECTORS

LOWER RISK: NO METAL OR PLASTIC COMPONENTS THAT CAN STRIKE WHEELS OR CAUSE VEHICLE DAMAGE



EASY AS...

INSTALL EASYSOX IN A SAFE PLACE AWAY FROM TRAFFIC. AFTER BRINGING VEHICLE TO A COMPLETE STOP, PUT VEHICLE IN PARK, TURN OFF ENGINE AND ENGAGE PARKING BRAKE.

LAY EASYSOX OVER THE DRIVE AXLE TIRES. STARTING FROM THE TOP OF THE TIRE, WORK THE EASYSOX OVER THE TREADFACE AND WRAP OVER THE INNER SIDEWALL OF THE TIRE, WORKING YOUR WAY DOWN TOWARD THE ROAD SURFACE.

PULL VEHICLE FORWARD (ABOUT A HALF REVOLUTION OF TIRE) UNTIL THE TIRE IS RESTING ON THE TOP OF THE MOUNTED SECTION OF THE EASYSOX. CONTINUE TO PULL THE FABRIC OVER THE INNER SIDEWALL UNTIL IT IS EVENLY DISTRIBUTED AROUND THE TIRE.



COMMERCIAL TRUCK / TRAILER / BUS

CRUZ TR CABLES

10.2mm metal rollers over cross cable. Ideal for low clearance vehicles. These cables are an economical alternative to traditional chains. Provides great emergency traction.

SINGLES		TRIPLES	
PART #	WEIGHT / PAIR	PART #	WEIGHT / PAIR
2314	7 Kg (15 lbs)	4314	13 Kg (29 lbs)
2315	7 Kg (16 lbs)	4315	15 Kg (33 lbs)
2316	8 Kg (17 lbs)	4316	15 Kg (34 lbs)
2317	8 Kg (18 lbs)	4317	19 Kg (41 lbs)
WIDE BASE SINGLES			
PART #	WEIGHT / PAIR		
3055	8.6 Kg (19 lbs)		
3057	9.1 Kg (20 lbs)		
3065	7.7 Kg (17 lbs)		
3071	9.5 Kg (21 lbs)		

ACCESSORIES

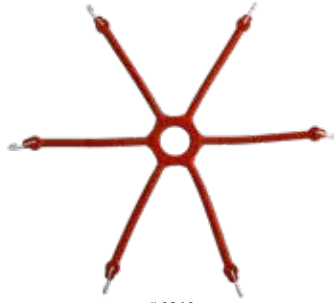

#0218

All spider tensioners sold separately



VOLT TRUCK PREMIUM DIAGONAL CABLES

17.3mm alloy steel rollers over cross cable. These diagonal pattern cables provide excellent emergency traction and a smooth ride. Premium quality.

SINGLES			
PART #	WEIGHT / PAIR	PART #	WEIGHT / PAIR
QV818	20.4 Kg (45 lbs)	QV881	16.8 Kg (37 lbs)
QV835	15.4 Kg (34 lbs)	QV887	17.7 Kg (39 lbs)
QV837	15.9 Kg (35 lbs)	QV891	18.1 Kg (40 lbs)
QV841	15.9 Kg (35 lbs)	QV892	18.1 Kg (40 lbs)
QV853	16.3 Kg (36 lbs)	QV896	21.3 Kg (47 lbs)
QV859	16.3 Kg (36 lbs)	QV897	19.5 Kg (43 lbs)
QV865	16.3 Kg (36 lbs)	QV898	20.9 Kg (46 lbs)
QV869	16.3 Kg (36 lbs)	QV899	20.0 Kg (44 lbs)
QV877	17.2 Kg (38 lbs)		

ACCESSORIES

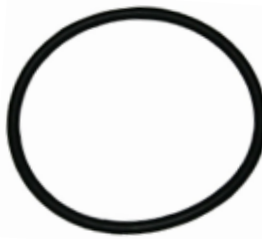

#QV1800

Tensioner included



COMMERCIAL TRUCK / TRAILER / BUS

PATHFINDER REGULAR TWIST LINK

7mm & 8mm* cross chains, carbon steel highway chains. NOT for use on plows, forklifts or tow trucks.



SINGLES		TRIPLES		CROSS CHAIN
PART #	WEIGHT / PAIR	PART #	WEIGHT / PAIR	
2233QC	13 Kg (29 lbs)	4233QC	36 Kg (79 lbs)	6251
2237QC	19 Kg (42 lbs)	4237QC	38 Kg (84 lbs)	
2239QC	20 Kg (44 lbs)	4239QC	37 Kg (82 lbs)	
2241QC	22 Kg (48 lbs)	4241QC	39 Kg (87 lbs)	
2245QC	23 Kg (51 lbs)	4245QC	43 Kg (95 lbs)	
2246QC	21 Kg (47 lbs)	4246QC	39 Kg (87 lbs)	6253
2247QC	23 Kg (50 lbs)	4247QC	43 Kg (94 lbs)	6258
2248QC	25 Kg (55 lbs)	4248QC	44 Kg (98 lbs)	
2249QC	24 Kg (53 lbs)	4249QC	44 Kg (96 lbs)	6253
2251QC*	31 Kg (69 lbs)	4251QC*	55 Kg (121 lbs)	6263
2255QC*	32 Kg (70 lbs)	4255QC*	60 Kg (132 lbs)	
2256QC*	35 Kg (77 lbs)	4256QC*	64 Kg (141 lbs)	
2257QC*	37 Kg (81 lbs)	4257QC*	65 Kg (143 lbs)	

ACCESSORIES



Cam Locks (QC) included

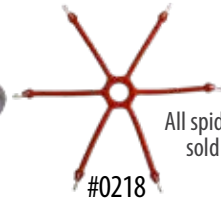

All spider tensioners sold separately

#0218

WIDE BASE SINGLES		CROSS CHAIN
PART #	WEIGHT / PAIR	
3255QC*	32 Kg (71 lbs)	7213
3257QC*	34 Kg (74 lbs)	7213
3259QC*	26 Kg (58 lbs)	7214
3261QC*	38 Kg (83 lbs)	7214
3265QC*	29 Kg (64 lbs)	7215
3267QC*	31 Kg (69 lbs)	7215
3269QC*	31 Kg (68 lbs)	7215
3271QC*	34 Kg (75 lbs)	7215



* 8mm cross chains

COMMERCIAL TRUCK / TRAILER / BUS

PATHFINDER SQUARE LINK ALLOY

7mm (SL) & 8mm* (HDSL) cross chains available. Alloy steel for durability. Square edge links dig into the driving surface providing excellent traction. Reversible for extra long life.



ACCESSORIES



All spider tensioners sold separately

#0218



Cam Locks (C) included

Call for details on Wide Base options

SINGLES		TRIPLES		CROSS CHAIN
PART #	WEIGHT / PAIR	PART #	WEIGHT / PAIR	
2137SLC	21 Kg (47 lbs)	4137SLC	42 Kg (92 lbs)	6251SL
2139SLC	28 Kg (61 lbs)	4139SLC	48 Kg (105 lbs)	6251SL
2141SLC	25 Kg (56 lbs)	4141SLC	48 Kg (105 lbs)	6251SL
2144SLC	24 Kg (52 lbs)	4144SLC	43 Kg (94 lbs)	6253SL
2146SLC	25 Kg (56 lbs)	4146SLC	46 Kg (102 lbs)	6253SL
2147SLC	28 Kg (61 lbs)	4147SLC	51 Kg (112 lbs)	6253SL
2149SLC	29 Kg (65 lbs)	4149SLC	55 Kg (121 lbs)	6253SL
2151SLC*	32 Kg (70 lbs)	4151SLC*	57 Kg (126 lbs)	6263SL
2155SLC*	34 Kg (74 lbs)	4155SLC*	60 Kg (133 lbs)	6263SL
2156SLC*	35 Kg (76 lbs)	4156SLC*	61 Kg (134 lbs)	6263SL
2157SLC*	36 Kg (79 lbs)	4157SLC*	62 Kg (136 lbs)	6263SL

Copy written by WCCANADA

*8mm cross chains

PATHFINDER CAN TRAC

The Can Trac is comprised of 5.5mm alloy steel which keeps the chain light and offers excellent strength. The diamond pattern creates a smooth ride and provides great on-road traction. The Can Trac is a great choice for operators looking for a lightweight traction solution.



SINGLES		CROSS CHAIN
PART #	WEIGHT / PAIR	
CT343QC	20 Kg (44 lbs)	CT55225
CT344QC	23 Kg (50 lbs)	CT55225
CT355QC	23 Kg (49 lbs)	CT55225



TRIPLES		CROSS CHAIN
PART #	WEIGHT / PAIR	
CT743QC	38 Kg (84 lbs)	CT55225
CT744QC	44 Kg (97 lbs)	CT55225
CT755QC	43 Kg (95 lbs)	CT55225

ACCESSORIES



Cam Locks included (QC)



All spider tensioners sold separately

#0218



COMMERCIAL TRUCK / TRAILER / BUS

PATHFINDER CANADIAN SPEC V-BAR

7mm & 8mm* (HD) alloy steel, V-Bar reinforced cross chains. V-bar chain provides excellent traction for extreme weather conditions and some off-road applications. Extra heavy-duty side chain & cross chain hooks for durability. Ensure your vehicle has the clearance for these chains prior to using them.



Call for details on Extra Heavy Duty 10mm options



SINGLES		TRIPLES		CROSS CHAIN
PART #	WEIGHT / PAIR	PART #	WEIGHT / PAIR	
V322	24 Kg (52 lbs)	V722	42 Kg (91 lbs)	V5315
V332	25 Kg (55 lbs)	V732	45 Kg (98 lbs)	V5330
V342	26 Kg (57 lbs)	V742	47 Kg (103 lbs)	V5340
V343	27 Kg (60 lbs)	V743	49 Kg (108 lbs)	V5340
V344	29 Kg (64 lbs)	V744	54 Kg (118 lbs)	V5340
V355*	34 Kg (75 lbs)	V755*	62 Kg (137 lbs)	V5355
V356*	37 Kg (81 lbs)	V756*	67 Kg (148 lbs)	V5355
V372*	42 Kg (92 lbs)	V772*	69 Kg (152 lbs)	V5360
V375*	41 Kg (90 lbs)	V775*	68 Kg (150 lbs)	V5370
V377*	43 Kg (94 lbs)	V777*	71 Kg (156 lbs)	V5370
V379*	42 Kg (93 lbs)	V779*	72 Kg (158 lbs)	V5370
V382*	43 Kg (95 lbs)	V782*	74 Kg (162 lbs)	V5370

ACCESSORIES



Available with Cam Locks (QC)

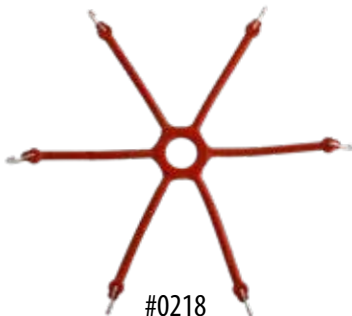

All spider tensioners sold separately

#0218



Copy write 2023 QCCANADA

COMMERCIAL TRUCK / TRAILER / BUS

PATHFINDER V-BAR LIGHTWEIGHT

6mm lightweight alloy steel, V-Bar reinforced through-hardened cross chains. V-bar chains provide excellent traction for extreme weather conditions and some off-road applications. 70% the weight of standard V-Bar chains increasing ease of installation. Cam locks included.



SINGLES		SINGLES		CROSS CHAIN
PART #	WEIGHT / PAIR	PART #	WEIGHT / PAIR	
2847LWQC	17 Kg (38 lbs)	4847LWQC	35 Kg (78 lbs)	6853LW
2849LWQC	19 Kg (42 lbs)	4849LWQC	38 Kg (83 lbs)	6853LW

ACCESSORIES

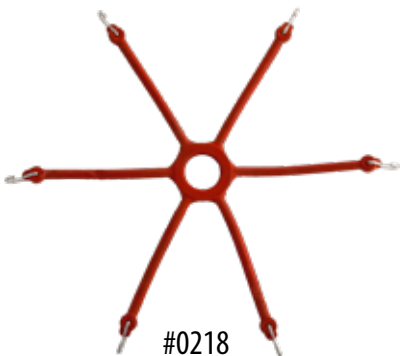

All spider tensioners sold separately



Cam Locks included (QC)



NORDIC™ STUDED ALLOY



8mm Super Alloy Studded

- Oversized studs and deep carburization for maximum strength and durability.
- 10mm hardened bell style hooks.
- 8mm hardened side chain.

7mm Super Alloy Studded

- 9mm oversized studs and deep carburization for maximum strength and durability.
- 9mm hardened bell style hooks.
- 8mm hardened side chain.

7mm Lightweight Super Alloy Studded

- 9mm oversized studs and deep carburization for maximum strength and durability.
- 8mm extra hardened bell style hook.
- 6mm hardened side chain.



NORDIC™ STUDED ALLOY



7MM LIGHT WEIGHT (LW)

SINGLES		TRIPLES		CROSS CHAIN
PART #	WEIGHT / PAIR	PART #	WEIGHT / PAIR	
S320LWQC	20 Kg (45 lbs)	S720LWQC	30 Kg (66 lbs)	6912L
S322LWQC	22 Kg (48 lbs)	S722LWQC	32 Kg (71 lbs)	6912L
S332LWQC	22 Kg (49 lbs)	S732LWQC	33 Kg (72 lbs)	6913L
S342LWQC	23 Kg (50 lbs)	S742LWQC	34 Kg (76 lbs)	6913L
S343LWQC	23 Kg (51 lbs)	S743LWQC	38 Kg (84 lbs)	6913L
S344LWQC	24 Kg (53 lbs)	S744LWQC	43 Kg (95 lbs)	6913L
S355LWQC	29 Kg (65 lbs)	S755LWQC	52 Kg (114 lbs)	6915L
S356LWQC	31 Kg (68 lbs)	S756LWQC	54 Kg (120 lbs)	6915L
S372LWQC	33 Kg (72 lbs)	S772LWQC	58 Kg (127 lbs)	6916L
S377LWQC	31 Kg (68 lbs)	S777LWQC	54 Kg (120 lbs)	6918L
S379LWQC	28 Kg (62 lbs)	S779LWQC	50 Kg (110 lbs)	6916L
S382LWQC	33 Kg (72 lbs)	S782LWQC	58 Kg (127 lbs)	6920L

7MM & 8MM* STANDARD

SINGLES		TRIPLES		CROSS CHAIN
PART #	WEIGHT / PAIR	PART #	WEIGHT / PAIR	
S320QC	24 Kg (52 lbs)	S720QC	42 Kg (93 lbs)	6912
S322QC	24 Kg (54 lbs)	S722QC	44 Kg (98 lbs)	6912
S332QC	26 Kg (57 lbs)	S732QC	45 Kg (100 lbs)	6913
S342QC	27 Kg (59 lbs)	S742QC	48 Kg (105 lbs)	6913
S343QC	29 Kg (64 lbs)	S743QC	52 Kg (115 lbs)	6913
S344QC	29 Kg (65 lbs)	S744QC	56 Kg (124 lbs)	6913
S355QC*	35 Kg (78 lbs)	S755*QC	64 Kg (140 lbs)	6925
S356QC*	38 Kg (80 lbs)	S756QC*	68 Kg (151 lbs)	6925
S372QC*	44 Kg (96 lbs)	S772QC*	74 Kg (163 lbs)	6926
S377QC*	44 Kg (98 lbs)	N/A	N/A	6931
S379QC*	47 Kg (104 lbs)	S779QC*	80 Kg (117 lbs)	6926
S382QC*	50 Kg (110 lbs)	S782QC*	85 Kg (187 lbs)	6932
S387QC*	54 Kg (118 lbs)	S787QC*	88 Kg (195 lbs)	6932

ACCESSORIES

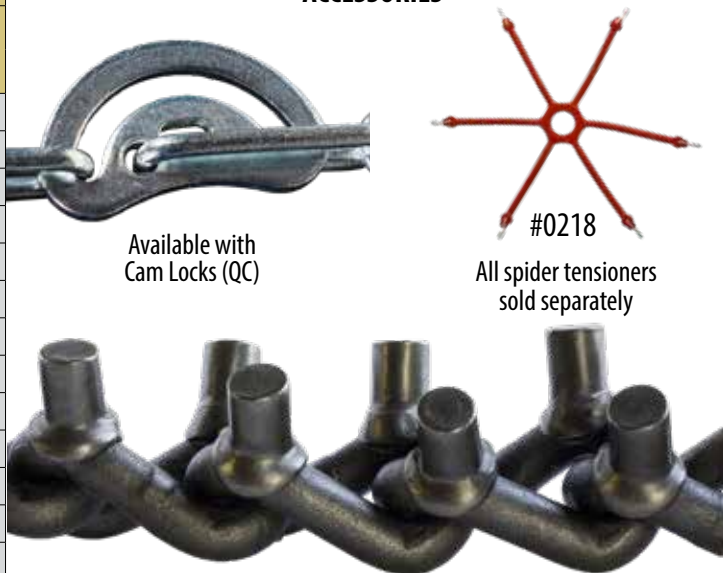

8MM HEAVY DUTY (HD)

SINGLES		TRIPLES		CROSS CHAIN
PART #	WEIGHT / PAIR	PART #	WEIGHT / PAIR	
S342HDQC	32 Kg (70 lbs)	S742HDQC	52 Kg (115 lbs)	6923
S343HDQC	34 Kg (75 lbs)	S743HDQC	59 Kg (130 lbs)	6923
S344HDQC	36 Kg (80 lbs)	S744HDQC	68 Kg (150 lbs)	6923

10MM EXTRA HEAVY DUTY (-10)

SINGLES		TRIPLES		CROSS CHAIN
PART #	WEIGHT / PAIR	PART #	WEIGHT / PAIR	
S342-10QC	32 Kg (71 lbs)	S742-10QC	57 Kg (126 lbs)	6927
S343-10QC	35 Kg (77 lbs)	S743-10QC	63 Kg (138 lbs)	6927
S344-10QC	36 Kg (79 lbs)	S744-10QC	68 Kg (149 lbs)	6927
S372-10QC	52 Kg (115 lbs)	S772-10QC	96 Kg (212 lbs)	6928
S377-10QC	50 Kg (110 lbs)	N/A	N/A	6929
S379-10QC	50 Kg (110 lbs)	S779-10QC	85 Kg (187 lbs)	6928
S382-10QC	55 Kg (120 lbs)	S782-10QC	117 Kg (258 lbs)	6930
S387-10QC	82 Kg (180 lbs)	S787-10QC	122 Kg (270 lbs)	6930



SKYDD LIGHTWEIGHT STUDDED ALLOY



**7mm Lightweight
SKYDD Studded**

- 6 Link Spacing
- 7mm hardened cross chain
- 6mm hardened side chain
- 8mm bell style hooks

7 mm Studded

- 7mm hardened cross chain
- 7mm hardened side chain
- 8mm bell style hooks

**8 mm Heavy-Duty
Studded**

- 8mm hardened cross chain
- 7mm hardened side chain
- 9mm bell style hooks



SKYDD

MILITARY



Best for aggressive off-road applications. Hardened alloy steel throughout for maximum life. Continuous pattern provides excellent traction in all directions for bars to dig into terrain.

PART #	TIRE SIZE	MATERIAL SIZE	WEIGHT / PAIR
QCC-515WB-007	8.25R16	7mm (9/32")	27 Kg (60 lbs)



QCCanada has full custom manufacturing capabilities and can design and produce chain for all types of military vehicles ready to handle any environment.



PART #	TIRE SIZE	MATERIAL SIZE	WEIGHT / PAIR
QCC-520WB-007	395/85R20	8mm	94 Kg (207 lbs)
QCC-521WB-007	14.00R20	8mm	98 Kg (217 lbs)
QCC-522WB-007	16.00R20	8mm	111 Kg (244 lbs)



INDUSTRIAL

TIRE SIZE	HEAVY DUTY CABLES	TWIST LINK ALLOY		TWIST LINK ALLOY H-PATTERN	SQUARE LINK ALLOY	SQUARE LINKE ALLOY WEAR-BAR PATTERN	NORDIC™ STUDDED ALLOY	NORDIC™ STUDDED ALLOY H-PATTERN	NORDIC™ SUPER GRIP PATTERN	NORDIC™ NON-STUDDED NET-LINK	NORDIC™ STUDDED NET-LINK
		REG TWIST	V-BAR	REG TWIST / V-BAR							
		PAGE 30	PAGE 30 & 31		PAGE 56	PAGE 32	PAGE 34	PAGE 33	PAGE 34	PAGE 35	PAGE 35
8" - 14" RIMS	5.00-8	1400F-10	1400F	1400FV		1400FSL					
	16X6-8	1400F-10	1400F	1400FV		1400FSL					
	18X7-8	1400F-10	1401F	1401FV		1401FSL					
	6.00-9	1400F-10	1401F	1401FV		1401FSL					
	21X8-9	1400F-12	1402F	1402FV		1402FSL					
	6.50-10	1400F-12	1402F	1402FV		1402FSL					
	7.50-10	1400F-12	1403F	1403FV		1403FSL					
	23X9-10	1400F-15	1406F	1406FV		1406FSL					
	7.00-12	1400F-12	1403F	1403FV		1403FSL					
	23X5.7-12				HP1739HD(V)						
	23X10-12	1400F-15	1406F	1406FV		1406FSL					
	27X10-12	1400F-15	1404F	1404FV		1404FSL					
	18X6X12-1/8	1400F-10	1400F	1400FV		1400FSL					
	18X7X12-1/8	1400F-10	1401F	1401FV		1401FSL					
	18X8X12-1/8	1400F-12	1401F	1401FV		1401FSL					
	18X9X12-1/8	1400F-12	1401F	1401FV		1401FSL					
	18X8X14	1400F-12	1401F	1401FV		1401FSL					
	18X9X14	1400F-12	1401F	1401FV		1401FSL					
15" RIMS	7.00-15	1400F-15	1404F	1404FV		1404FSL					
	7.50-15	1400F-15	1405F	1405FV		1405FSL					
	8.15-15	1400F-15	1404F	1404FV		1404FSL					
	8.25-15	1400F-15	1408F	1408FV		1408FSL					
	21X5X15	1400F-10	1401F	1401FV		1401FSL					
	21X6X15	1400F-10	1401F	1401FV		1401FSL					
	21X7X15	1400F-10	1401F	1401FV		1401FSL					
	21X8X15	1400F-12	1402F	1402FV		1402FSL					
	21X9X15	1400F-12	1402F	1402FV		1402FSL					
	21X12X15	1400F-15									
	27X10.50-15		1500	1500V	HP1748HD(V)	1500HDSL					
	28X9-15	1400F-15	1404F	1404FV		1404FSL					
	28X12.5-15	1400F-15	1407F	1407FV		1407FSL					
	31X15.50-15		1502	1502V	1502HP(V)	1502HDSL	1502WB-8	1502S	1502SHP-8		
	32X12.1-15	1400F-18	1502	1502V	1502HP(V)	1502HDSL	1502WB-8	1502S	1502SHP-8		
33X12.50-15		1502	1502V	1502HP(V)	1502HDSL	1502WB-8	1502S	1502SHP-8			
250-15	1400F-15	1405F	1405FV		1405FSL						
300-15	1400F-18	1409F	1409FV		1409FSL						
16" RIMS	7.50-16	1400F-15	1405F	1405FV		1405FSL					
	22X5X16	1400F-10	1402F	1402FV		1402FSL					
	22X6X16	1400F-10	1402F	1402FV		1402FSL					
	22X7X16	1400F-10	1402F	1402FV		1402FSL					
	22X8X16	1400F-12	1402F	1402FV		1402FSL					

INDUSTRIAL

TIRE SIZE	HEAVY DUTY CABLES	TWIST LINK ALLOY		TWIST LINK ALLOY H-PATTERN	SQUARE LINK ALLOY	SQUARE LINK ALLOY WEAR-BAR PATTERN	NORDIC™ STUDDED ALLOY	NORDIC™ STUDDED ALLOY H-PATTERN	NORDIC™ SUPER GRIP PATTERN	NORDIC™ NON-STUDDED NET-LINK	NORDIC™ STUDDED NET-LINK
		REG TWIST	V-BAR	REG TWIST / V-BAR							
		PAGE 30	PAGE 30 & 31		PAGE 56	PAGE 32	PAGE 34	PAGE 33	PAGE 34	PAGE 35	PAGE 35
16" - 19.5" RIMS	22X9X16	1400F-12	1403F	1403FV		1403FSL					
	10-16.5		1501	1501V	1501HP(V)	1501HDSLS		1501S			
	12-16.5		1502	1502V	1502HP(V)	1502HDSLS	1502WB-8	1502S	1502SHP-8		
	265/70R16.5		1501	1501V	1501HP(V)	1501HDSLS		1501S			
	31X13.00-16.5		1502	1502V	1502HP(V)	1502HDSLS	1502WB-8	1502S	1502SHP-8		
	33X15.50-16.5		1503	1503V		1503HDSLS	1503WB-8	1503S	1503SHP		
	14-17.5		1503	1503V		1503HDSLS	1503WB-8	1503S	1503SHP		
	22X6X17-3/4	1400F-10	1401F	1401FV		1401FSL					
	22X8X17-3/4	1400F-12	1402F	1402FV		1402FSL					
	22X10X17-3/4	1400F-15	1403F	1403FV		1403FSL					
	12.5/80R18		1504	1504V	DUO210(V) 1504HP(V)	1504HDSLS		1504S	DUO210S-8 1504SHP-10		
	15.5/70-18		1505	1505V	1505HP(V)	1505HDSLS		1505S	1505SHP-10		
	340/80R18		1504	1504V	DUO210(V) 1504HP(V)	1504HDSLS		1504S	DUO210S-8 1504SHP-10		
	365/70R18		1504	1504V	1504HP(V)	1504HDSLS		1504S	1504SHP-10		
	400/70R18		1505	1505V	1505HP(V)	1505HDSLS		1505S	1505SHP-10		
	405/70R18		1506	1506V		1506HDSLS		1506S			
	15-19.5	3065	1505	1505V	DUO241(V) 1505HP(V)	1505HDSLS		1505S	1505SHP-10		
	18-19.5				DUO264(V)						
385/65-19.5		1505	1505V	1505HP(V)	1505HDSLS		1505S	1505SHP-10			
445/65R19.5		2612C	V379 2612CV	DUO242(V)	6512A		S379 2912A	DUO242S-8 2912SHP-10	2912NSG		
20" - 22.5" RIMS	12.00R20	2317 A891, QV891	1506	1506V		1506HDSLS		1506S			
	13/80R20		1504	1504V	1504HP(V)	1504HDSLS		1504S	1504SHP-10		
	14.00R20		2612C	V382 2612CV		6512A	QCC-521WB-007	S382 2912A	2912SHP-10	2912NSG	
	32X10-20		1501	1501V	1501HP(V)	1501HDSLS		1501S			
	33X12-20		1502	1502V	1502HP(V)	1502HDSLS	1502WB-8	1502S	1502SHP-8		
	38X18.00-20		1505	1505V	1505HP(V)	1505HDSLS		1505S	1505SHP-10		
	400/70R20		1506	1506V	DUO243(V)	1506HDSLS		1506S			
	405/70R20		1506	1506V	DUO243(V)	1506HDSLS		1506S			
	425/75R20					CALL FOR ASSISTANCE					
	43X16.00-20				DUO239(V)						
	28X10X22	1400F-15	1404F	1404FV		1404FSL					
	28X12X22	1400F-15	1408F	1408FV		1408FSL					
	15-22.5		1506	1506V		1506HDSLS		1506S			
24" RIMS	12.00R24		2257 2610C	V379 2610CV		2157SLC 6510A		S379 2910A	2910SHP		
	13.00R24		2612C	2612CV	DUO242(V)	6512A		2912A	DUO242S-8 2912SHP-10	2912NSG	
	14.00R24		2615C	2615CV	DUO260(V)	6515A	6515WB	S387 2915A	2915SHP	2915NSG	
	16.00R24		2627C	2627CV-10		6527A	6527WB	2927A	2927SHP	2927NSG	
	17.5LR24		2623C	2623CV-10	DUO265(V)	6523A		2923A	2923SHP	2923NSG	
	19.5LR24		2626C	2626CV-10	DUO268(V)	6526A	6526WB-8	2926A	2926SHP	2926RNSG	
	21LR24				DUO271(V)				DUO271S	2930RNSG	
	385/95R24		2615C	2615CV	DUO260(V)	6515A	6515WB	S387 2915A	2915SHP	2915NSG	

INDUSTRIAL

TIRE SIZE	TWIST LINK ALLOY		TWIST LINK ALLOY H-PATTERN	SQUARE LINK ALLOY	SQUARE LINKE ALLOY WEAR-BAR PATTERN	NORDIC™ STUDDUED ALLOY	NORDIC™ STUDDUED ALLOY H-PATTERN	NORDIC™ SUPER GRIP PATTERN	NORDIC™ NON-STUDDUED NET-LINK	NORDIC™ STUDDUED NET-LINK	NORDIC™ TOP MOUNT U-GRIP NET-LINK	
	REG TWIST	V-BAR	REG TWIST / V-BAR									
	PAGE 30 & 31		PAGE 56	PAGE 32	PAGE 34	PAGE 33	PAGE 34	PAGE 35	PAGE 35	PAGE 36	PAGE 42	
24" - 25" RIMS	460/70R24	2623C	2623CV-10	DUO265(V)	6523A		2923A	2923SHP	2923NSG			
	500/70R24	2626C	2626CV-10	DUO268(V)	6526A	6526WB-8	2926A	2926SHP	2926RNSG			
	540/70R24			DUO271(V)				DUO271S	2930RNSG			
	15-625	1505	1505V	1505HP(V)	1505HDSLS		1505S	1505SHP-10				
	14.00R25	2615C	2615CV	DUO260(V)	6515A	6515WB	S387 2915A	2915SHP	2915NSG			
	15.5R25	2612C	2612CV		6512A		2912A	2912SHP	2912NSG			
	16.00R25	2627C	2627CV-10		6527A	6527WB-10	2927A	2927SHP	2927NSG			
	17.5R25	2624C	2624CV-10	DUO268(V)	6524A	6524WB-10	2924A	2924SHP	2924NSG			
	18.00R25	2636C	2636CV-10		6536A		2936A	2936SHP	2936NSG		NLS180	
	20.5R25	2633C	2633CV-10		6533A	6533WB	2933A	2933SHP	2933NSG	NLN205 DHN205	NLS205 DHS205	
	21.00R25	2642C	2642CV-10		6542A		2942A	2942SHP	2942NSG			
	23.5R25	2645C	2645CV-10		6545A	6545WB	2945A	2945SHP	2945NSG	NLN235 DDN235	NLS235 DDS235	
	24.00R25						CALL FOR ASSISTANCE					
	25/65R25	2645C	2645CV-10		6545A	6545WB	2945A	2945SHP	2945NSG	NLN235 DDN235	NLS235 DDS235	
	26.5R25	2657C			6557A	6557WB	2957A	2957SHP	2957NSG	NLN265 DDN265	NLS265 DDS265	DDU2652534
	29.5R25	2672C			6572A		2972A	2972SHP	2972NSG	NLN295 DDN295	NLS295 DDS295	
	30/65R25	2656C			6556A	6556WB	2956A	2956SHP	2956NSG	NLN750 DDN750	NLS750 DDS750	
	525/80R25	2633C	2633CV-10		6533A	6533WB	2933A	2933SHP	2933NSG	NLN205 DHN205	NLS205 DHS205	
	550/65R25	2633C	2633CV-10		6533A	6533WB	2933A	2933SHP	2933NSG	NLN205 DHN205	NLS205 DHS205	
	600/65R25	2633C	2633CV-10		6533A	6533WB	2933A	2933SHP	2933NSG	NLN205 DHN205	NLS205 DHS205	
650/65R25	2645C	2645CV-10		6545A	6545WB	2945A	2945SHP	2945NSG	NLN235 DDN235	NLS235 DDS235		
750/65R25	2656C			6556A	6556WB	2956A	2956SHP	2956NSG	NLN750 DDN750	NLS750 DDS750		
28" - 57" RIMS	16.9R28			DUO262(V)								
	370/75-28	2612C	2612CV	DUO242(V)	6512A		2912A	2912SHP	2912NSG			
	400/75-28	2615C	2615CV	DUO260(V)	6515A	6515WB	S387 2915A	2915SHP	2915NSG			
	440/80R28			DUO262(V)								
	26.5R29						CALL FOR ASSISTANCE					
	29.5R29	2675C			6575A		2975A					
	35/65R29									NLN87565	DDS87565	
	875/65R29									NLN87565	DDS87565	
	18.00R33	2642C	2642CV-10		6542A		2942A	2942SHP	2942NSG			
	33.5R33						CALL FOR ASSISTANCE					
	35/65R33	2680C			6580A		2980A			NLN3565 DDN3565	NLS3565 DDS3565	
	37.5R33						CALL FOR ASSISTANCE					
	21.00R35						CALL FOR ASSISTANCE					
	24.00R35										NLS2400	
	29.5R35						CALL FOR ASSISTANCE					
	27.00R49											
	33.00R51										NLS3300	
	36.00R51										NLS3600	
40.00R57										NLS4000		

INDUSTRIAL

HEAVY DUTY CABLES



8mm alloy rollers provide exceptional longevity and a smooth ride, reducing vibration. These chains can be run on both sides. Double duty cross cables (2 link spacing) offer more coverage and better continual traction. Comes with a 0213 spider tensioner & cable cutters for custom fitment.

PART #	WEIGHT / PAIR
1400F-10	7 Kg (13 lbs)
1400F-12	10 Kg (22 lbs)
1400F-15	12 Kg (27 lbs)
1400F-18	14 Kg (31 lbs)

Note: Machine operator must be aware that rapid direction change can destroy cables!



REGULAR TWIST LINK



Ladder style cross chains produce moderate traction in uneven terrain. Available in single duty 4 link spacing and double duty 2 link spacing (-2). Double duty cross chains offer more coverage and better continual traction.

PART #	WEIGHT / PAIR	CROSS CHAIN	MATERIAL SIZE
1400F	5 Kg (12 lbs)	6216	5.5mm
1401F	8 Kg (18 lbs)	6218	5.5mm
1402F	13 Kg (28 lbs)	6248	7mm
1403F	18 Kg (40 lbs)	6255	8mm
1404F	19 Kg (42 lbs)	6256	8mm
1405F	21 Kg (46 lbs)	6256	8mm
1406F	19 Kg (42 lbs)	6260	8mm
1407F	22 Kg (48 lbs)	6260	8mm
1408F	25 Kg (56 lbs)	6256	8mm
1409F	25 Kg (55 lbs)	6260	8mm



PART #	WEIGHT / PAIR	CROSS CHAIN	MATERIAL SIZE
1500	18 Kg (40 lbs)	6260	8mm
1501	20 Kg (44 lbs)	6260	8mm
1502	25 Kg (54 lbs)	6268	8mm
1503	26 Kg (58 lbs)	6268	8mm
1504	28 Kg (62 lbs)	6268	8mm
1505	30 Kg (66 lbs)	6270	8mm
1506	32 Kg (70 lbs)	6270	8mm



ACCESSORIES



All spider tensioners sold separately



1500 series chains are available with Cam Locks (QC)

INDUSTRIAL

REGULAR TWIST LINK

Case hardened twist link chains available in 10mm, 11mm and 13mm. Great for plows, graders forklifts and scrapers. Single duty 4 link spacing & double duty 2 link spacing (-2) available. **ALSO AVAILABLE IN 10MM V-BAR (V).**

PART #	WEIGHT / PAIR	CROSS CHAIN	ADJUSTER
2612C	49 Kg (108 lbs)	6630	0294
2615C	57 Kg (126 lbs)	6630	
2624C	74 Kg (162 lbs)	6640	
2627C	88 Kg (195 lbs)	6640	
2633C	86 Kg (190 lbs)	6650	
2636C	95 Kg (210 lbs)	6650	0296
2642C	112 Kg (246 lbs)	6650	
2645C	164 Kg (362 lbs)	6660	
2656C	200 Kg (441 lbs)	6670	
2657C	204 Kg (450 lbs)	6670	
2660C	214 Kg (472 lbs)	6670	
2672C	228 Kg (503 lbs)	6680	
2675C	241 Kg (531 lbs)	6680	
2678C	267 Kg (589 lbs)	6690	
2680C	277 Kg (610 lbs)	6690	
2682C	309 Kg (681 lbs)	6692	
2686C	318 Kg (702 lbs)	6693	
2688C	320 Kg (706 lbs)	6694	

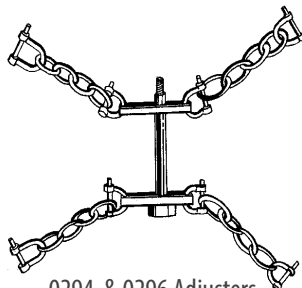

0294 & 0296 Adjusters sold separately



V-BAR

Alloy steel reinforced V-Bar. Available in single duty 4 link spacing and double duty 2 link spacing (-2). Double duty offers more coverage and therefore improved traction. V-bars dig into the driving surface for excellent traction in ice, snow, and mud.

PART #	WEIGHT / PAIR	CROSS CHAIN	MATERIAL SIZE
1400FV	6 Kg (13 lbs)	6816	5.5mm
1401FV	9 Kg (19 lbs)	6818	5.5mm
1402FV	13 Kg (29 lbs)	6848	7mm
1403FV	19 Kg (41 lbs)	6855	8mm
1404FV	20 Kg (43 lbs)	6856	8mm
1405FV	22 Kg (48 lbs)	6856	8mm
1406FV	20 Kg (43 lbs)	6860	8mm
1407FV	23 Kg (50 lbs)	6860	8mm
1408FV	26 Kg (58 lbs)	6856	8mm
1409FV	26 Kg (57 lbs)	6860	8mm

ACCESSORIES

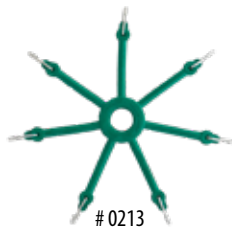

0213

All spider tensioners sold separately

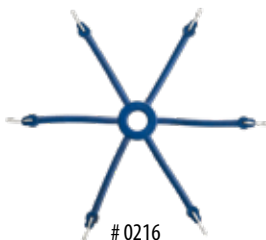

0216



1500 series chains are available with Cam Locks (QC)



1500V	20 Kg (44 lbs)	6860	8mm
1501V	22 Kg (48 lbs)	6860	8mm
1502V	27 Kg (59 lbs)	V5355	8mm
1503V	29 Kg (64 lbs)	V5355	8mm
1504V	31 Kg (69 lbs)	V5355	8mm
1505V	33 Kg (72 lbs)	V5370	8mm
1506V	35 Kg (77 lbs)	V5370	8mm

INDUSTRIAL

SQUARE LINK ALLOY



Designed for maximum traction. Alloy square link cross chain edges bite into ice and are reversible for extended longevity. Available in single duty 4 link spacing and double duty 2 link spacing (-2). Double duty offers more coverage and better continual traction.

PART #	WEIGHT / PAIR	CROSS CHAIN	MATERIAL SIZE
1400FSL	4 Kg (8 lbs)	6216SL	5.5mm
1401FSL	5 Kg (12 lbs)	6218SL	5.5mm
1402FSL	27 Kg (30 lbs)	6248SL	7mm
1403FSL	21 Kg (46 lbs)	6255SL	8mm
1404FSL	20 Kg (44 lbs)	6256SL	8mm
1405FSL	25 Kg (55 lbs)	6256SL	8mm
1406FSL	19 Kg (42 lbs)	6260SL	8mm
1407FSL	18 Kg (39 lbs)	6260SL	8mm
1408FSL	26 Kg (58 lbs)	6256SL	8mm
1409FSL	27 Kg (60 lbs)	6260SL	8mm



ACCESSORIES



All spider tensioners sold separately

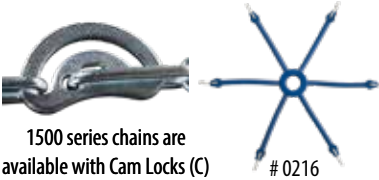

1500 series chains are available with Cam Locks (C)



1500HDSLS	20 Kg (44 lbs)	6260SL	8mm
1501HDSLS	22 Kg (48 lbs)	6263SL	8mm
1502HDSLS	27 Kg (59 lbs)	6268SL	8mm
1503HDSLS	29 Kg (64 lbs)	6268SL	8mm
1504HDSLS	31 Kg (69 lbs)	6268SL	8mm
1505HDSLS	33 Kg (73 lbs)	6270SL	8mm
1506HDSLS	35 Kg (78 lbs)	6270SL	8mm

SQUARE LINK ALLOY

10mm 11mm & 13mm alloy square link cross chains. Alloy steel used for durability. Square edge links dig into driving surface. These chains can be run on both sides. For plows, graders, forklifts, and scrapers. Available in single duty 4 link spacing and double duty 2 link spacing (-2).

PART #	WEIGHT / PAIR	CROSS CHAIN	ADJUSTER
6512A	54 Kg (120 lbs)	E6530S	0294
6515A	64 Kg (140 lbs)	E6530S	
6524A	92 Kg (202 lbs)	E6540SH	0296
6527A	97 Kg (214 lbs)	E6540SH	
6533A	105 Kg (232 lbs)	E6550SH	
6536A	114 Kg (252 lbs)	E6550SH	
6542A	173 Kg (382 lbs)	E6550SH	
6545A	139 Kg (307 lbs)	E6560SH	
6556A	204 Kg (438 lbs)	E6570SH	
6557A	209 Kg (460 lbs)	E6570SH	
6572A	272 Kg (600 lbs)	E6580SH	
6575A	286 Kg (631 lbs)	E6580SH	
6580A	329 Kg (725 lbs)	E6590SH	

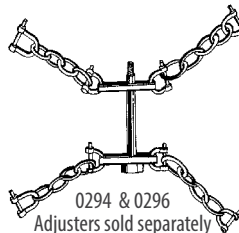

INDUSTRIAL

NORDIC™ STUDED ALLOY



Premium 8mm studded cross chains. Alloy steel for longer wear. Studs dig into driving surface for excellent traction in harsh conditions. Available in single duty 4 link spacing and double duty 2 link spacing (-2). Double duty offers more coverage and better continual traction.

PART #	WEIGHT / PAIR	CROSS CHAIN
1500S	21 Kg (46 lbs)	6923
1501S	23 Kg (50 lbs)	6923
1502S	28 Kg (61 lbs)	6926
1503S	30 Kg (66 lbs)	6926
1504S	32 Kg (71 lbs)	6926
1505S	39 Kg (85 lbs)	6931
1506S	41 Kg (90 lbs)	6931



ACCESSORIES



Available with Cam Locks (QC)

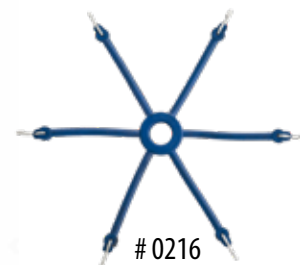

0216
All spider tensioners sold separately

NORDIC™ STUDED ALLOY

10mm, 11mm, and 13mm hardened alloy steel construction for maximum life. Excellent traction in harsh conditions. Designed for plows, graders, forklifts, scrapers, loaders, etc. Available in single duty 4 link spacing and double duty 2 link spacing (-2).



PART #	WEIGHT / PAIR	CROSS CHAIN	ADJUSTER
2912A	57 Kg (126 lbs)	6930	0294
2915A	48 Kg (105 lbs)	6930	
2924A	73 Kg (162 lbs)	6940	
2927A	80 Kg (177 lbs)	6940	0296
2933A	97 Kg (214 lbs)	6950	
2936A	105 Kg (232 lbs)	6950	
2942A	177K g (390 lbs)	6950	
2945A	143K g (315 lbs)	6960	
2956A	199 Kg (438 lbs)	6970	
2957A	201 Kg (444 lbs)	6970	
2972A	286 Kg (631 lbs)	6980	
2975A	329 Kg (725 lbs)	6980	

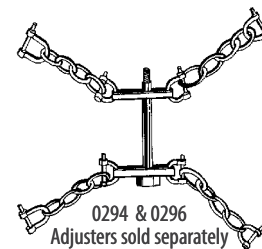

0294 & 0296
Adjusters sold separately

INDUSTRIAL

WEAR-BAR SQUARE LINK SINGLE DIAMOND

Wear-bar pattern chain provides excellent continual traction both on and off road. The Wear bar pattern will not damage road surface during snow removal or damage rig mats when moving equipment on and off. Comes with side chain tensioning system.

PART #	WEIGHT / PAIR	ADJUSTER
1502WB-8	48 Kg (106 lbs)	-
1503WB-8	63 Kg (140 lbs)	
6515WB-10	174 Kg (383 lbs)	0294
6515WB-11	180 Kg (396 lbs)	
6524WB-10	171 Kg /376 lbs)	
6526WB-8	118 Kg (260 lbs)	-
6527WB-10	171 Kg (376 lbs)	0296
6533WB-11	270 Kg (595 lbs)	
6533WB-13	313 Kg (690 lbs)	
6545WB-13	360 Kg (794 lbs)	
6556WB-13	361 Kg (795 lbs)	
6557WB-13	376 Kg (829 lbs)	

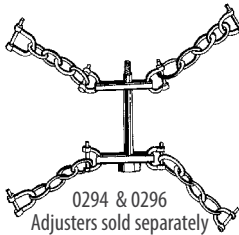

NORDIC™ STUDDED H-PATTERN

10mm, 11mm, and 13mm studded cross patterns.
Best for aggressive off-road applications.
Hardened alloy steel throughout for maximum life.
H-patterns prevent chain from settling below the lugs.



PART #	STANDARD MATERIAL SIZE	MATERIAL SIZES ALSO AVAILABLE	STANDARD WEIGHT / PAIR	STANDARD PATTERN	ADJUSTER
1502SHP-8	8mm	-	47 Kg (103 lbs)	8500	-
1503SHP-8	8mm	-	54 Kg (120 lbs)	8500	-
1505SHP-10	10mm	-	125 Kg (275 lbs)	8502	-
1510SHP-10	10mm	-	73 Kg (160 lbs)	8502	-
2912SHP	10mm	11mm	112 Kg (246 lbs)	8502	0294
2915SHP	10mm	11mm, 13mm	120 Kg (264 lbs)	8502	
2924SHP	10mm	11mm, 13mm	132 Kg (290 lbs)	8502	0296
2927SHP	10mm	11mm, 13mm	134 Kg (296 lbs)	8502	
2933SHP	11mm	13mm	170 Kg (375 lbs)	8505	
2936SHP	11mm	13mm	180 Kg (396 lbs)	8505	
2942SHP	13mm	11mm	280 Kg (618 lbs)	8505	
2945SHP	13mm	11mm	245 Kg (541 lbs)	8508	
2956SHP	13mm	-	282 Kg (622 lbs)	8509	
2957SHP	13mm	-	289 Kg (638 lbs)	8509	
2972SHP	13mm	-	311 Kg (685 lbs)	8509	
2975SHP	13mm	-	332 Kg (732 lbs)	8511	

See page 56 for Regular Twist Link & V-bar H-pattern options (Duo-Grip)

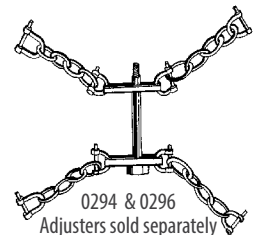

INDUSTRIAL

NORDIC™ SUPER GRIP STUDDED

10mm, 11mm, 13mm and 16mm cross patterns. Best for aggressive off-road applications. Hardened alloy steel throughout for maximum life. Continuous pattern provides excellent traction in all directions for studs to dig into terrain. Smooth and comfortable ride on solid surfaces.

PART #	STANDARD MATERIAL SIZE	MATERIAL SIZES ALSO AVAILABLE	STANDARD WEIGHT / PAIR	ADJUSTER
2912NSG	11mm	10mm	136 Kg (300 lbs)	0294
2915NSG	11mm	10mm, 13mm	147 Kg (324 lbs)	
2924NSG	11mm	10mm, 13mm	153 Kg (337 lbs)	0296
2927NSG	11mm	10mm, 13mm	152 Kg (336 lbs)	
2933NSG	11mm	10mm, 13mm	164 Kg (361 lbs)	
2936NSG	11mm	10mm, 13mm	181 Kg (400 lbs)	
2942NSG	11mm	13mm	215 Kg (473 lbs)	
2945NSG	13mm	11mm	269 Kg (594 lbs)	
2956NSG	13mm	16mm	282 Kg (622 lbs)	
2957NSG	13mm	16mm	289 Kg (638 lbs)	
2972NSG	16mm	-	516 Kg (1137 lbs)	

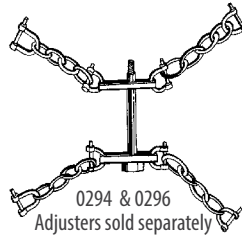

NORDIC™ NON-STUDDED NET-LINK

14mm, 16mm, 18mm, & 19mm cross patterns. Hardened alloy steel construction for maximum life. Diamond patterns form a net over the tire providing excellent coverage and continual traction. No studs for less aggressive applications.



PART #	STANDARD MATERIAL SIZE	MATERIAL SIZES ALSO AVAILABLE	STANDARD WEIGHT / PAIR
NLN180	16mm	-	422 Kg (930 lbs)
NLN205	16mm	-	408 Kg (900 lbs)
NLN235	16mm	14mm	347 Kg (764 lbs)
NLN265	16mm	18mm	415 Kg (916 lbs)
NLN295	18mm	16mm	666 Kg (1469 lbs)
NLN3565	19mm	16mm	813 Kg (1792 lbs)
NLN87565	16mm	-	524 Kg (1155 lbs)

ACCESSORIES

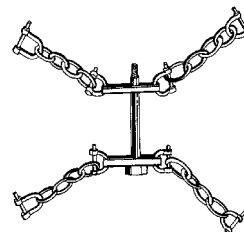

HD Chain Tightener
2506HD sold separately

INDUSTRIAL

NORDIC™ STUDDED NET-LINK

16mm, 18mm, & 20mm studded cross patterns. Alloy steel construction for maximum life. Diamond patterns form a net over the tire, providing excellent coverage and continual contact with ground surface. Aggressive traction for harsh conditions.

PART #	STANDARD MATERIAL SIZE	MATERIAL SIZES ALSO AVAILABLE	STANDARD WEIGHT / PAIR
NLS180	16mm	-	387 Kg (845 lbs)
NLS205	16mm	-	345 Kg (761 lbs)
NLS235	16mm	-	532 Kg (1172 lbs)
NLS265	16mm	20mm	464 Kg (1023 lbs)
NLS295	16mm	18mm, 20mm	617 Kg (1360 lbs)
NLS2400	20mm	-	920 Kg (2029 lbs)
NLS2700	20mm	-	1434 Kg (3128 lbs)
NLS3300	20mm	-	1832 Kg (4039 lbs)
NLS3565	18mm	-	868 Kg (1914 lbs)
NLS3600	20mm	-	2046 Kg (4510 lbs)



ACCESSORIES

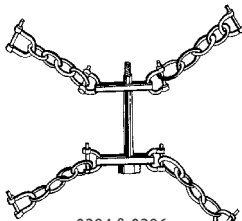

0294 & 0296
Adjusters sold separately



HD Chain Tightener
2506HD sold separately



NORDIC™ STUDDED NET-LINK - SINGLE STUD

17mm studded cross patterns. Alloy steel construction for maximum life. Diamond patterns form a net over the tire, providing excellent coverage and continual contact with ground surface. Aggressive traction for harsh conditions. Also available in non-studded (DHN / DDN).

PART #	MATERIAL SIZE	WEIGHT / PAIR
DHS180-17	17mm	472 Kg (1040 lbs)
DHS205-17	17mm	437 Kg (963 lbs)
DDS235-17	17mm	472 Kg (1040 lbs)
DDS265-17	17mm	549 Kg (1210 lbs)
DDS295-17	17mm	580 Kg (1278 lbs)
DDS3565-17	17mm	739 Kg (1630 lbs)
DDS750-17	17mm	474 Kg (1046 lbs)
DDS87565-17	17mm	703 Kg (1550 lbs)

0294 & 0296 Adjusters & 2506HD Chain Tightener sold separately



MINING

NORDIC™ WEAR-BAR NET-LINK

20mm wear-bar net-link patterns. Alloy steel construction for maximum life. Diamond patterns form a net over the tire, providing excellent coverage and continual contact with ground surface. Aggressive traction for harsh conditions.

TIRE SIZE	PART #	MATERIAL SIZE	WEIGHT / PAIR
29.5R29	NLTB29529-20	20mm	1386 Kg (3056 lbs)



NORDIC™ MINING TRACTION NET-LINK

Utilizing forged studs the Nordic™ Armour Mining Traction Net-Link chain is built for the world's most demanding environments. Nordic™ Armour chain is in a class of its own, providing unsurpassed durability and traction.

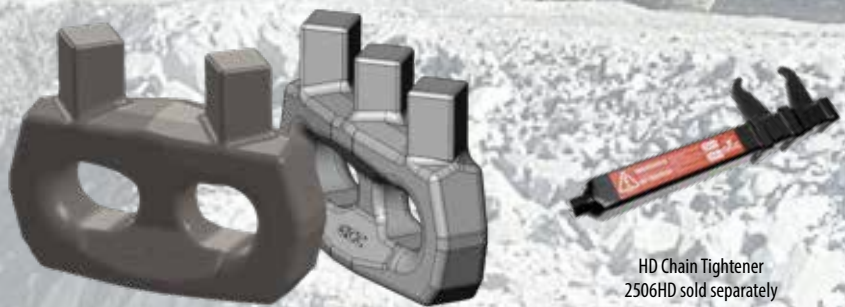

HD Chain Tightener
2506HD sold separately

1.5 DIAMOND NET-LINK PATTERN

TIRE SIZE	PART #	MATERIAL SIZE	WEIGHT / PAIR
23.5R25	NLM235-16	16mm	599 Kg (1320 lbs)

TRIPLE DIAMOND NET-LINK PATTERN

TIRE SIZE	PART #	MATERIAL SIZE	WEIGHT / PAIR
50/65-51	NLTM5065-22	22mm	3646 Kg (8039 lbs)
40.00R57	NLTM4000-22	22mm	4051 Kg (8930 lbs)
53/80R63	NLTM538063-22	22mm	4235 Kg (9337 lbs)

THE NORDIC™ ARMOUR PROTECTION CHAIN



NORDIC™ ARMOUR HIGH-WEAR LUG

Tires represent the most expensive maintenance costs for the mining industry. The Nordic™ Armour Protection chain increases tire life by protecting the tires surface from excessive wear, punctures and cuts.

TIRE SIZE	PART #	RING SIZE
17.5R25	NAWL175-18	18mm
23.5R25	NAWL235-20	20mm
26.5R25	NAWL265-20	20mm
29.5R25	NAWL295-20	20mm
29.5R29	NAWL29529-20	20mm
875/65R29	NAWL87565-20	20mm
35/65R33	NAWL3565-20	20mm
40/65-39	NAWL4065-22	22mm
45/65R45	NAWL456545-22	22mm
50/65R51	NAWL5065-22	22mm
50/80R57	NAWL5080-22	22mm
52/80-57	NAWL5280-22	22mm
58/85-57	NAWL5885-22	22mm
60/80R57	NAWL6080-22	22mm
53/80R63	NAWL538063-22	22mm



NORDIC™ STUDDED DOUBLE DIAMOND NET-LINK



Our net-link chain uses weld on studs providing grip and durability in icy or rocky conditions. Available in 16mm, 18mm and 20mm material sizes. Double diamond configuration.

TIRE SIZE	PART #	STANDARD MATERIAL SIZE	MATERIAL SIZES ALSO AVAILABLE	STANDARD WEIGHT / PAIR
23.1-26	NLS231-16	16mm	-	492 Kg (1084 lbs)
750/50-26.5	NLS750/55-16	16mm	-	501 Kg (1105 lbs)
750/55-26.5				
24.5-32	NLS245-18	18mm	16mm	676 Kg (1490 lbs)
30.5L32	NLS305-20A	20mm	16mm, 18mm	692 Kg (1525 lbs)
35.5L32	NLS355-20A	20mm	18mm	842 Kg (1857 lbs)
73X44.00-32	NLS730-20	20mm	-	907 Kg (2000 lbs)

ACCESSORIES



Chain Tightener
2506HD
Sold Separately



NORDIC™ STUDDED TRIPLE DIAMOND NET-LINK

Our net link chain uses weld on studs providing grip and durability in icy or rocky conditions. Available in 16mm, 18mm and 20mm material sizes. Triple diamond configuration.

TIRE SIZE	PART #	STANDARD MATERIAL SIZE	MATERIAL SIZES ALSO AVAILABLE	STANDARD WEIGHT / PAIR
30.5L32	NLTS305-18	18mm	-	943 Kg (2078 lbs)
35.5L32	NLTS355-20	20mm	18mm	1108 Kg (2442 lbs)
73X44.00-32	NLTS730-20	20mm	16mm, 18mm	1111 Kg (2449 lbs)
76X50.00-32	NLTS760-16	16mm	-	865 Kg (1908 lbs)

2506HD Chain Tightener sold separately



NORDIC™ STUDED DOUBLE DIAMOND NET-LINK - SINGLE STUD

17mm studded cross patterns. Alloy steel construction for maximum life. Diamond patterns form a net over the tire, providing excellent coverage and continual contact with ground surface. Aggressive traction for harsh conditions.



TIRE SIZE	PART #	MATERIAL SIZE	WEIGHT / PAIR
23.1-26	DDS231-17	17mm	472 Kg (1040 lbs)
710/45-26.5	DDS71045-17	17mm	455 Kg (1003 lbs)
750/50-26.5	DDS75055-17	17mm	475 Kg (1047 lbs)
750/55-26.5			
700/50-30.5	DDS70050305-17	17mm	472 Kg (1040 lbs)
24.5-32	DDS245-17	17mm	519 Kg (1144 lbs)
30.5L32	DDS305-17	17mm	580 Kg (1278 lbs)
35.5L32	DDS355-17	17mm	739 Kg (1630 lbs)
700/70-34	DDS7007034-17	17mm	549 Kg (1210 lbs)

2506HD Chain Tightener sold separately



NORDIC™ SINGLE & 1.5 DIAMOND TOP MOUNT U-GRIP NET-LINK

These chains offer incredible durability thanks to our unique heat treatment process and large 7/8" to 1-1/8" material size. The use of top mounted U-Studs maximizes traction and prevents the chain from rolling over. Both of these chains are great options for operators looking for incredible traction and wear life while not needing the coverage of a double or triple diamond chain.

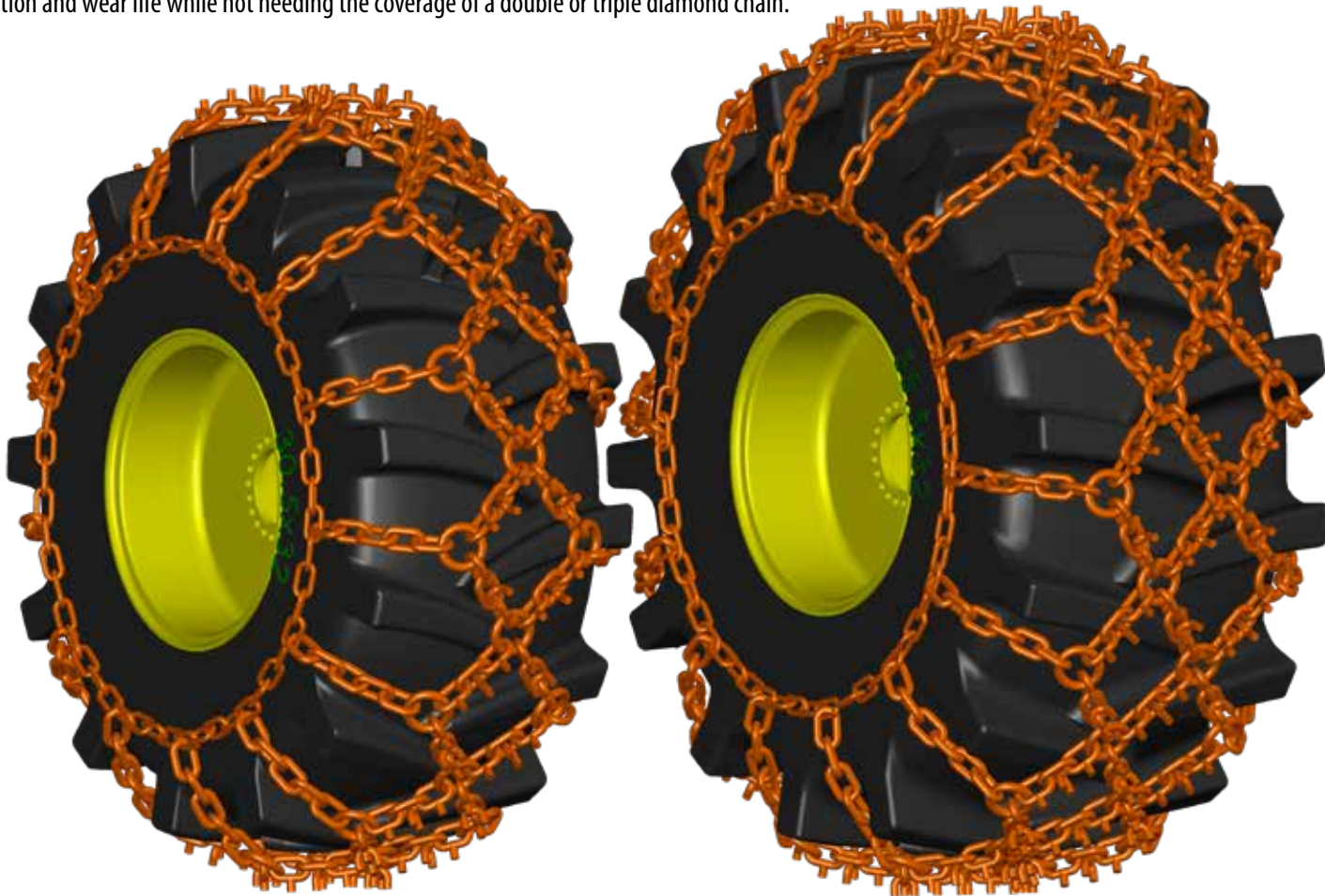

SDU

DHU

TIRE SIZE	PART #	STANDARD MATERIAL SIZE	MATERIAL SIZES ALSO AVAILABLE	STANDARD WEIGHT / PAIR
23.1-26	SDU2312634	19mm	16mm	307 Kg (677 lbs)
28L-26	SDU282678	22mm	-	646 Kg (1425 lbs)
16.9-30	SDU16930916-58	14mm/16mm	-	215 Kg (474 lbs)
24.5-32	SDU2453278	22mm	16mm	702 Kg (1547 lbs)
30.5L32	SDU3053278	22mm	-	734 Kg (1688 lbs)
35.5L32	DHU3553278	22mm	-	1042 Kg (2297 lbs)
	SDU35532118	28mm	-	941 Kg (2072 lbs)
18.4-34	SDU1843434	19mm	14mm/16mm, 16mm	305 Kg (673 lbs)

ACCESSORIES



Chain Tightener
2506HD Sold Separately



Copy write 2015

NORDIC™ DOUBLE DIAMOND TOP MOUNT U-GRIP NET-LINK

Top mounted U studs prevent the chain from rolling and ensures continual traction. Double diamond pattern forms a net over the tire providing excellent coverage. Available in 19mm material size with 20mm U studs.



2506HD Chain Tightener sold separately

TIRE SIZE	PART #	MATERIAL SIZE	WEIGHT / PAIR
28L-26	DDU282658	16mm	653 Kg (1440 lbs)
24.5-32	DDU2453258	16mm	653 Kg (1440 lbs)
30.5L32	DDU3053234	19mm	668 Kg (1473 lbs)
35.5L32	DDU3553234	19mm	742 Kg (1636 lbs)
710/70R38	DDU710703834	19mm	735 Kg (1620 lbs)
26.5R25	DDU2652534	19mm	717 Kg (1580 lbs)

Also available for industrial tire

FORESTRY

NORDIC™ DOUBLE DIAMOND U-GRIP NET-LINK



The under mount U-Stud provides the ultimate in stability and traction. The NLU is built for the most demanding forestry environments. Available in 16mm, 18mm, 20mm & 22mm material sizes. Double diamond configuration.

TIRE SIZE	PART #	STANDARD MATERIAL SIZE	MATERIAL SIZES ALSO AVAILABLE	STANDARD WEIGHT / PAIR
23.1-26	NLU231-16	16mm	-	390 Kg (860 lbs)
24.5-32	NLU245-16	16mm	-	576 Kg (1270 lbs)
30.5L32	NLU305-20A	20mm	-	769 Kg (1696 lbs)
35.5L32	NLU355-20A	20mm	22mm	913 Kg (2013 lbs)
73X44.00-32	NLU730-18	18mm	16mm	777 Kg (1712 lbs)

ACCESSORIES



Chain Tightener
2506HD
Sold Separately



NORDIC™ TRIPLE DIAMOND U-GRIP NET-LINK



The under mount U-Stud provides the ultimate in stability and traction. The NLU is built for the most demanding forestry environments. Available in 16mm, & 20mm material sizes. Triple diamond configuration.



TIRE SIZE	PART #	MATERIAL SIZE	WEIGHT / PAIR
35.5L32	NLTU355-20	20mm	1265 Kg (2789 lbs)
73X44.00-32	NLTU730-16	16mm	785 Kg (1731 lbs)
	NLTU730-20	20mm	1318 Kg (2905 lbs)

2506HD Chain Tightener sold separately

Copy write 2023 QCCANA

NORDIC™ TRIPLE DIAMOND TOP MOUNT U-GRIP NET-LINK

Our TDU was designed with forwarder, harvester and skidder floatation tires in mind. The TDU chain uses top mounted U studs in a tight triple diamond design to ensure continual traction and tire coverage. The design incorporates a tensioning chain to ensure a secure fit regardless of tire make or levels of wear. Side chain design also offers additional protection for tire side walls. The TDU is available in 16mm & 14mm material sizes in a triple diamond configuration. Tension chain only available with metric sized tires. Also available with additional studded links between each U-Grip link (X) for added traction, ask about TDUX options.

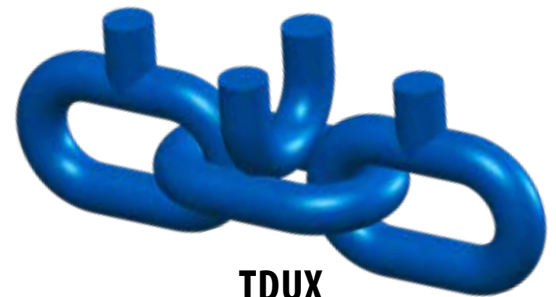
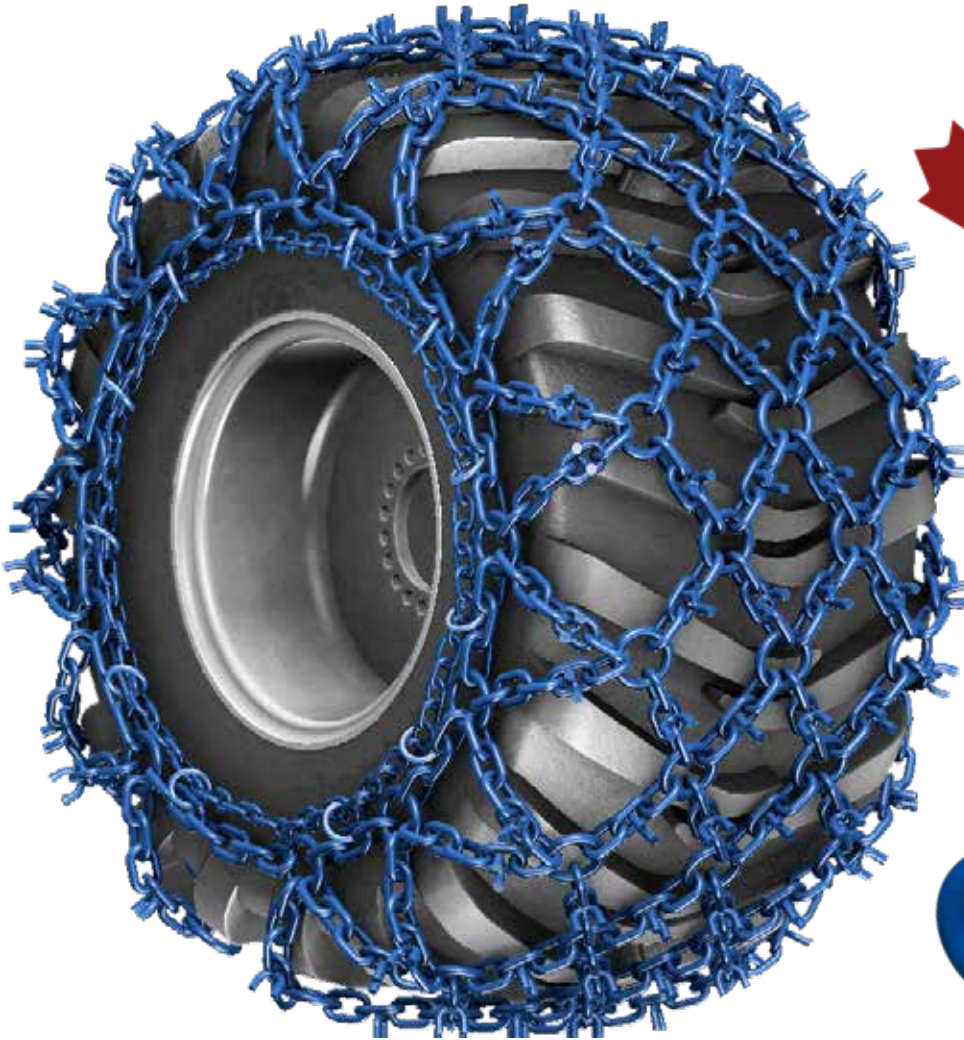

TDUX
Extra Studded Option

TIRE SIZE	PART #	STANDARD MATERIAL SIZE	MATERIAL SIZES ALSO AVAILABLE	STANDARD WEIGHT / PAIR
600/55-26.5	TDU6005558	16mm	14mm	353 Kg (777 lbs)
700/50-26.5	TDU7104558	16mm	14mm	428 Kg (942 lbs)
710/45-26.5				
750/50-26.5				
750/55-26.5	TDU7505558	16mm	14mm	519 Kg (1142 lbs)
780/55-26.5				
780/50-28.5	TDU7805058	16mm	-	571 Kg (1256 lbs)
73X44.00-32	TDU73443258	16mm	-	766 Kg (1689 lbs)
76X50.00-32	TDU76503258	16mm	-	860 Kg (1896 lbs)

ACCESSORIES



Chain Tightener
2506HD sold separately

NORDIC™ NET-LINK FORGED FORESTRY CHAIN

Our most aggressive and longest lasting skidder chain, utilizing forged studs and 22mm connecting rings. The Nordic™ Net-Link Forged Forestry chain is built for the world's most demanding forestry environments. Nordic™ Forestry chain is in a class of its own, providing unsurpassed durability and traction.

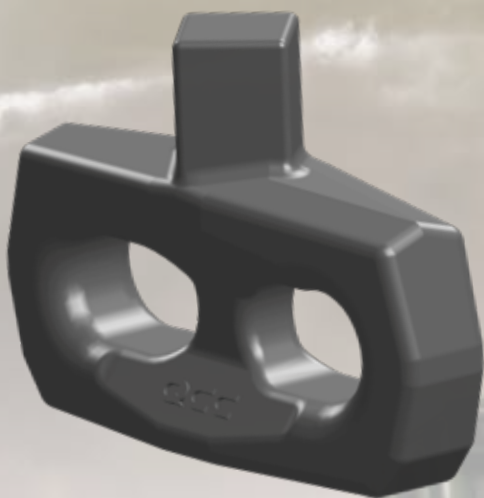
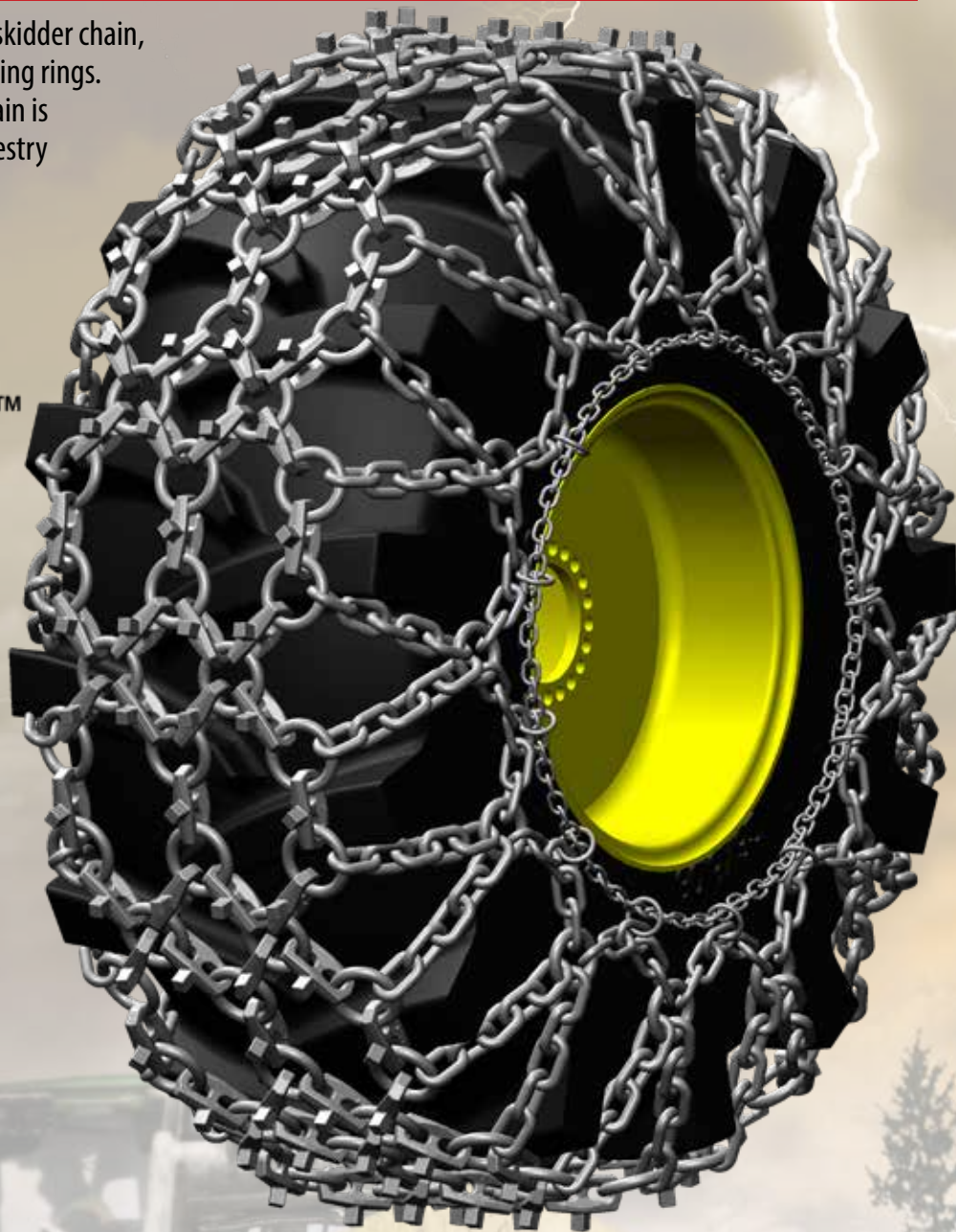

SINGLE STUD

Its unique patent pending design will not allow snow and mud to accumulate. Traction will never be compromised.

ACCESSORIES



Chain Tightener 2506HD sold separately

TIRE SIZE	PART #	MATERIAL SIZE	WEIGHT / PAIR
750/50-26.5	NTFF75055-22	22mm	648 Kg (1426 lbs)
750/55-26.5			
780/50-28.5	NTFF78050-22	22mm	720 Kg (1584 lbs)
24.5-32	NTFF245-22	22mm	909 Kg (2004 lbs)
30.5L32	NTFF305-22	22mm	993 Kg (2189 lbs)
35.5L32	NTFF355-22	22mm	1136 Kg (2504 lbs)

THE NORDIC™ **ARMOUR** FORGED FORESTRY PROTECTION CHAIN

Tires represent the most expensive maintenance costs for forestry skidders. The Nordic™ Armour forged forestry protection chain increases tire life by protecting the tires surface from excessive wear, punctures and cuts. The Nordic™ Armour is available in either a single or triple stud depending on operational needs.

TRIPLE STUD

Patent pending design used for traction with minimal ground disturbance.

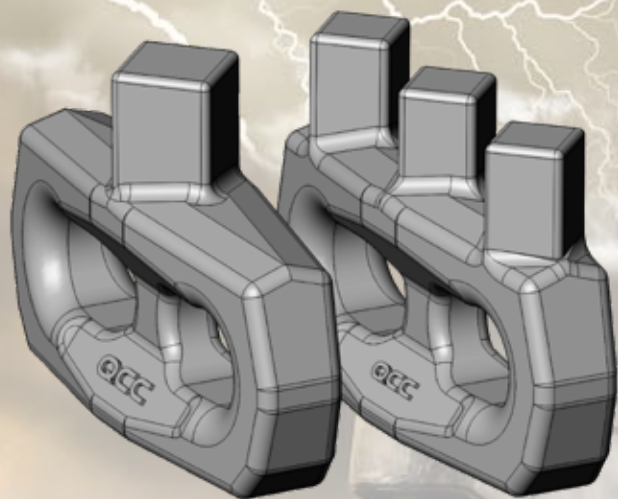

SINGLE STUD - EXTREME

Used for traction in the most extreme environments. Its unique patent pending design will not allow snow and mud to accumulate. Traction will never be compromised.



SINGLE STUD EXTREME	TIRE SIZE	PART #	MATERIAL SIZE	WEIGHT / PAIR
	30.5L32	NLTFFPE305-22	22mm	1267 Kg (2793 lbs)
	35.5L32	NLTFFPE355-22	22mm	1399 Kg (3084 lbs)
	73X44.00-32	NLQFFPE730-22	22mm	1690 Kg (3726 lbs)

TRIPLE STUD	TIRE SIZE	PART #	MATERIAL SIZE	WEIGHT / PAIR
	30.5L32	NLTFFP305-22	22mm	1352 Kg (2981 lbs)
	35.5L32	NLTFFP355-22	22mm	1449 Kg (3194 lbs)
	73X44.00-32	NLQFFP730-22	22mm	1779 Kg (3922 lbs)

Chain Tightener 2506HD sold separately

FORESTRY

NORDIC™ RING CHAIN

Alloy steel fixed ring chain with 16mm connecting links & 28mm rings.

TIRE SIZE	PART #	STANDARD SIZE CONNECTING LINK	MATERIAL SIZES ALSO AVAILABLE	STANDARD WEIGHT / PAIR
23.1-26	RA231-16	16mm	-	300 Kg (663 lbs)
24.5-32	RA245-16	16mm	-	355 Kg (782 lbs)
18.4-34	RA184-16	16mm	14mm	300 Kg (663 lbs)



Grouser made of fully forged steel

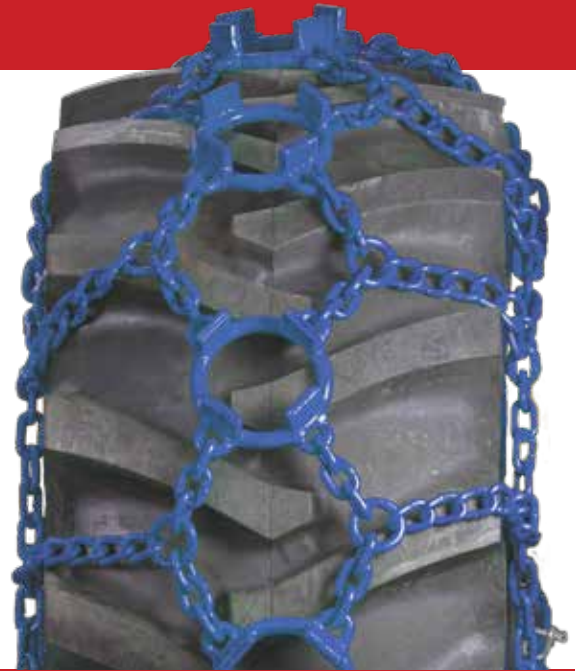

NORDIC™ TIGHT RING CHAIN

Alloy steel fixed ring chain with rings spaced closer together than standard ring chain for better continual traction. 16mm & 18mm connecting links, 28mm rings.



TIRE SIZE	PART #	STANDARD SIZE CONNECTING LINK	MATERIAL SIZES ALSO AVAILABLE	STANDARD WEIGHT / PAIR
23.1-26	RAT231-18	18mm	16mm	362 Kg (798 lbs)
24.5-32	RAT245-16	16mm	-	405 Kg (893 lbs)
30.5L32	RAT305-18	18mm	-	688 Kg (1516 lbs)
35.5L32	RAT355-18	18mm	-	715 Kg (1576 lbs)
73X44.00-32	RAT730-18	18mm	-	725 Kg (1599 lbs)
18.4-34	RAT184-18	18mm	16mm	367 Kg (809 lbs)

NORDIC™ FLOATING RING CHAIN

Alloy steel rings are fully floating to help shed mud and debris. 16mm & 18mm connecting links, 28mm rings.

TIRE SIZE	PART #	STANDARD SIZE CONNECTING LINK	MATERIAL SIZES ALSO AVAILABLE	STANDARD WEIGHT / PAIR
23.1-26	RAF231-16	16mm	-	395 Kg (871 lbs)
24.5-32	RAF245-16	16mm	18mm	516 Kg (1137 lbs)
30.5L32	RAF305-18	18mm	16mm	600 Kg (1322 lbs)
35.5L32	RAF355-18	18mm	-	636 Kg (1402 lbs)
73X44.00-32	RAF730-18	18mm	25mm (RAFT*)	628 Kg (1384 lbs)

ACCESSORIES



Chain Tightener 2506HD
sold separately



***25mm fully floating tight multi ring chain (RAFT) also available**



Copy write 2023 QCCANADA

NORDIC™ MULTI RING CHAIN

Grouser made of fully forged steel



NORDIC™ tire chains engineered in Canada

25mm (1") Forged Connecting Links



Alloy steel multi-ring chain complete with staggered main and sub rings. This configuration allows for more tire coverage and traction when compared to single ring.

TIRE SIZE	PART #	MATERIAL SIZE	WEIGHT / PAIR
30.5L32	RAMF305-25	25mm	848 Kg (1870 lbs)
35.5L32	RAMF355-25	25mm	967 Kg (2132 lbs)
73X44.00-32	RAMF730-25	25mm	829 Kg (1828 lbs)

AGRICULTURE / UTILITY

TIRE SIZE	REGULAR TWIST LINK	V-BAR	TWIST LINK ALLOY PATTERN		
			REG TWIST LINK	V-BAR	
	PAGE 52		PAGE 51		
4" - 6" RIMS	4.10/3.50-4	1703-2			
	3.40/3.00-5	1703-2			
	4.10-5	1706-2			
	4.10/3.50-5	1706-2			
	10X2.75	1700-2			
	10.25X3.25	1700-2			
	4.10/3.50-6	1706-2			
	5.30-6	1715-2	1715HDV-2	HP1715	HP1715V
	5.30/4.50-6	1715-2	1715HDV-2	HP1715	HP1715V
	13X5.00-6	1709-2			
	13X6.50-6	1712-2	1712HDV-2		
	14X4.00-6	1709-2			
	14.5X7.00-6	1715-2	1715HDV-2	HP1715	HP1715V
	145/70-6	1715-2	1715HDV-2	HP1715	HP1715V
	15X5.00-6	1710-2	1715HDV-2	HP1715	HP1715V
15X6.00-6	1710-2	1715HDV-2	HP1715	HP1715V	
8" RIMS	4.00-8	1715-2	1715HDV-2	HP1715	HP1715V
	4.80-8	1715-2	1715HDV-2	HP1715	HP1715V
	4.80/4.00-8	1715-2	1715HDV-2	HP1715	HP1715V
	15X6.50-8	1715-2	1715HDV-2	HP1715	HP1715V
	16X6.50-8	1718-2		HP1718	HP1718V
	18X6.50-8	1721-2	1721HDV-2	HP1721	HP1721V
	18X8.50-8	1724-2		HP1724	HP1724V ATV-234
	18.9.50-8	1727-2		HP1727	HP1727V
	20X8.00-8	1730-2	1730HDV-2	HP1730	HP1730V
20X10.00-8	1733-2	1733HDV-2	HP1733	HP1733V ATV-362	
10" - 12" RIMS	18X8.50-10	1724-2		HP1724	HP1724V
	20X8.00-10	1730-2	1730HDV-2	HP1730	HP1730V
	20X10.00-10	1733-2	1733HDV-2	HP1733	HP1733V
	22X10.00-10	1736-2	1736HDV-2	HP1736	HP1736V
	6-12	1739-2		HP1739	HP1739V
	7-12	1742-2	1742HDV-2	HP1742	HP1742V
	23X8.50-12	1742-2	1742HDV-2	HP1742	HP1742V ATV-335
	23X9.50-12	1736-2	1736HDV-2	HP1736	HP1736V
	23X10.50-12	1736-2	1736HDV-2	HP1736	HP1736V ATV-335
	24X12.00-12	1745-2 ATV-C-2	1745HDV-2	HP1745	HP1745V
	25X8.50-12				ATV-424
	26X12.00-12	1748-2	1748HDV-2	HP1748	HP1748V ATV-461
	320/60-12				ATV-483

MINI DUO-GRIP H-PATTERN TWIST LINK & V-BAR



5.5mm & 7mm Heavy Duty (HD) options available.
Regular Twist Link or V-Bar (V) cross patterns.
H-patterns provide great continual & lateral traction.
Reinforced V-Bars provide excellent traction in harsh conditions.

TWIST LINK PART #	WEIGHT / PAIR	V-BAR PART #	WEIGHT / PAIR
HP1715	10 Kg (22 lbs)	HP1715V	10 Kg (22 lbs)
HP1718	15 Kg (32 lbs)	HP1718V	16 Kg (36 lbs)
HP1721	11 Kg (24 lbs)	HP1721V	8 Kg (18 lbs)
HP1724	10 Kg (21 lbs)	HP1724V	11 Kg (23 lbs)
HP1727	11 Kg (25 lbs)	HP1727V	13 Kg (28 lbs)
HP1730	14 Kg (30 lbs)	HP1730V	15 Kg (33 lbs)
HP1733HD	16 Kg (36 lbs)	HP1733HDV	21 Kg (47 lbs)
HP1736HD	16 Kg (35 lbs)	HP1736HDV	18 Kg (40 lbs)
HP1739HD	15 Kg (34 lbs)	HP1739HDV	19 Kg (41 lbs)
HP1742HD	19 Kg (42 lbs)	HP1742HDV	13 Kg (29 lbs)
HP1745HD	22 Kg (48 lbs)	HP1745HDV	26 Kg (57 lbs)
HP1748HD	25 Kg (55 lbs)	HP1748HDV	26 Kg (57 lbs)
HP1749HD	28 Kg (61 lbs)	HP1749HDV	30 Kg (67 lbs)
HP1751HD	24 Kg (52 lbs)	HP1751HDV	30 Kg (67 lbs)
HP1753HD	27 Kg (60 lbs)	HP1753HDV	27 Kg (60 lbs)
HP1754HD	27 Kg (60 lbs)	HP1754HDV	27 Kg (59 lbs)
HP1757HD	21 Kg (46 lbs)	HP1757HDV	19 Kg (41 lbs)
HP1760HD	25 Kg (55 lbs)	HP1760HDV	25 Kg (55 lbs)
HP1763HD	16 Kg (35 lbs)	HP1763HDV	27 Kg (59 lbs)
HP1766HD	32 Kg (71 lbs)	HP1766HDV	35 Kg (78 lbs)
HP1769HD	66 Kg (65 lbs)	HP1769HDV	66 Kg (65 lbs)

AGRICULTURE / UTILITY

TIRE SIZE	REGULAR TWIST LINK	V-BAR	TWIST LINK ALLOY PATTERN		NORDIC™ STUDDED ALLOY H-PATTERN	
			REG TWIST LINK	V-BAR		
	PAGE 52		PAGE 51		PAGE 34	
14" - 15" RIMS	7-14	1754-2	HP1754	HP1754V ATV-382		
	25X8.50-14	1754-2	HP1754	HP1754V		
	7.60-15	1753-2	HP1753	HP1753V		
	27X8.50-15	1753-2	HP1753	HP1753V		
	27X10.50-15	1748-2 1500-2	1500V-2	HP1748	HP1748V ATV-461	
	28X9.00-15				ATV-486	
	29X12.00-15	1749-2		HP1749	HP1749V	
	36X13.50-15	1503-2	1503V-2	1503HP	1503HPV	1503SHP
16" - 16.1" RIMS	7-16	1753-2	HP1753	HP1753V		
	8.3-16	1760-2	HP1760HD	HP1760HDV		
	9.5-16	1763-2	HP1763HD	HP1763HDV		
	11.00-16	1766-2	HP1766HD	HP1766HDV		
	11.2-16	1502-2	1502V-2	1502HP	1502HPV	1502SHP-8
	12.4-16			DUO238	DUO238V	
	13.6-16	1772-2 1504-2	1504V-2	DUO210 1504HP	DUO210V 1504HPV	DUO210S-8 1504SHP-10
	13.50-16.1SL			DUO238	DUO238V	
	18.4-16.1			DUO264	DUO264V	

ACCESSORIES



0213

All spider tensioners sold separately



0216



7300HD

Chain Pliers sold separately

REGULAR TWIST LINK

4.5mm, 5.5mm or 7mm cross chains. Comes standard in double duty 2 link spacing (-2) for added coverage and traction with driving surface. **V-BAR OPTIONS ALSO AVAILABLE.**

PART #	WEIGHT / PAIR	CROSS CHAIN
1700-2	2 Kg (5 lbs)	5411
1703-2	3 Kg (6 lbs)	5411
1706-2	3 Kg (7 lbs)	5411
1709-2	4 Kg (8 lbs)	5412
1710-2	4 Kg (8 lbs)	5412
1712-2	6 Kg (12 lbs)	5414
1715-2	5 Kg (11 lbs)	5414
1718-2	9 Kg (20 lbs)	5414
1721-2	8 Kg (17 lbs)	5414
1724-2	9 Kg (20 lbs)	5420
1727-2	6 Kg (13 lbs)	5423
1730-2	6 Kg (14 lbs)	5420
1733-2	10 Kg (22 lbs)	5422

PART #	WEIGHT / PAIR	CROSS CHAIN
1736-2	9 Kg (19 lbs)	5422
1739-2	12 Kg (26 lbs)	5422
1742-2	7 Kg (15 lbs)	5420
1745-2	13 Kg (29 lbs)	5425
1748-2	13 Kg (29 lbs)	5425
1749-2	15 Kg (33 lbs)	5425
1751-2	14 Kg (30 lbs)	5425
1753-2	13 Kg (28 lbs)	5420
1754-2	13 Kg (28 lbs)	5420
1760-2	16 Kg (35 lbs)	6253
1763-2	20 Kg (43 lbs)	6258
1766-2	26 Kg (58 lbs)	6258
1769-2	29 Kg (64 lbs)	6258
1772-2	39 Kg (86 lbs)	6265



AGRICULTURE / UTILITY

TIRE SIZE	REGULAR TWIST LINK	V-BAR	TWIST LINK ALLOY PATTERN		NORDIC™ STUDDED ALLOY H-PATTERN	NORDIC™ SUPER GRIP PATTERN	NORDIC™ STUDDED NET-LINK
			REG TWIST LINK	V-BAR			
	PAGE 31 & 52		PAGE 51 & 56		PAGE 34	PAGE 57	PAGE 41 & 42
16.1" - 19.5" RIMS	21.5-16.1SL			DUO264	DUO264V		
	10-16.5	1760-2 1501-2	1501V-2	HP1760HD 1501HP	HP1760HDV 1501HPV		
	265/70R16.5	1760-2 1501-2	1501V-2	HP1760HD 1501HP	HP1760HDV 1501HPV		
	9.5-18	1766-2		HP1766HD	HP1766HDV		
	10.5/80-18	1766-2		HP1766HD	HP1766HDV		
	12.5/80-18	1504-2	1504V-2	DUO210	DUO210V	DUO210S-8	
	15.5/60-18			DUO238	DUO238V		
	340/80R18	1504-2	1504V-2	DUO210	DUO210V	DUO210S-8	
	400/70R18	1505-2	1505V-2	1505HP	1505HPV	1505SHP-10	
	15-19.5	1505-2	1505V-2	DUO241 1505HP	DUO241V 1505HPV	1505SHP-10	
	40X19-19.5			DUO264	DUO264V		
20" RIMS	355/80R20	3257-2					
	360/70R20	1505-2	1505V-2	DUO241 1505HP	DUO241V 1505HPV	1505SHP-10	
	360/80R20	1506-2	1506V-2				
	400/70R20	1506-2	1506V-2	DUO243	DUO243V		
	405/70R20	1506-2	1506V-2	DUO243	DUO243V		
	41X14.00-20			DUO240	DUO240V		
	425/75R20			CALL FOR ASSISTANCE			
	43X16.00-20			DUO239	DUO239V		
	44X18.00-20			DUO264	DUO264V		
	48X31.00-20						2951RNSG-10
22.5" - 24" RIMS	600/50-22.5						2941RNSG-10
	8.3-24	1766-2		HP1766HD	HP1766HDV		
	9.5-24	1769-2		HP1769HD DUO214	HP1769HDV DUO214V	DUO214S-8	
	11.2-24			DUO210	DUO210V	DUO210S-8	
	12.4-24			DUO229	DUO229V		
	13.6-24			DUO240	DUO240V		
	14.9-24	2612C-2	2612CV-2	DUO242	DUO242V	2912SHP-10	2912RNSG-10
	16.9-24	2615C-2	2615CV-2	DUO260	DUO260V	2915SHP	2915NSG
	17.5L-24	2623C-2	2623CV-10-2	DUO265	DUO265V	2923SHP	2923NSG
	18.4-24			DUO268	DUO268V		
	19.5L-24	2626C-2	2626CV-10-2	DUO268	DUO268V	2926SHP	2926RNSG
	21L-24			DUO271	DUO271V	DUO271S	2930RNSG
	320/85R24			DUO229	DUO229V		
	340/85R24			DUO240	DUO240V		
	380/85R24			DUO242	DUO242V		
	420/70R24	2615C-2	2615CV-2	DUO250	DUO250V	2915SHP	2918RNSG-10
460/70R24	2623C-2	2623CV-10-2	DUO265	DUO265V	2923SHP	2923NSG	
500/70R24	2626C-2	2626CV-10-2	DUO268	DUO268V	2926SHP	2926RNSG	

AGRICULTURE / UTILITY

TIRE SIZE	REGULAR TWIST LINK	V-BAR	TWIST LINK ALLOY PATTERN		NORDIC™ STUDED ALLOY H-PATTERN	NORDIC™ SUPER GRIP PATTERN	NORDIC™ STUDED NET-LINK	
			REGTWIST LINK	V-BAR				
	PAGE 31		PAGE 56		PAGE 34	PAGE 57	PAGE 35, 36, 41, 42	
24" - 28" RIMS	540/70R24		DUO271	DUO271V	DUO271S	2930RNSG		
	13.6-26		DUO240	DUO240V				
	14.9-26		DUO250	DUO250V				
	16.9-26	2615C-2	2615CV-2	DUO260	DUO260V	2915SHP	2925RNSG-10	
	18.4-26			DUO268	DUO268V			
	23.1-26			DUO280	DUO280V		SDU2312658 DDS231	
	28L-26						DDU282658 SDU282678	
	420/85R26	2615C-2	2615CV-2	DUO260	DUO260V	2915SHP	2925RNSG-10	
	9.5R28			DUO214	DUO214V	DUO214S-8		
	11.2-28			DUO226	DUO226V			
	12.4-28			DUO218	DUO218V		2910RNSG-10	
	13.6-28	2612C-2	2612CV-2	DUO242	DUO242V	2912SHP-10	2912NSG	
	14.9-28			DUO250	DUO250V			
	16.9-28			DUO262	DUO262V			
	18.4-28			DUO271	DUO271V	DUO271S	2912NSG	
	340/85R28	2612C-2	2612CV-2	DUO242	DUO242V	2912SHP-10	2912NSG	
	380/85R28			DUO250	DUO250V			
	420/85R28			DUO262	DUO262V			
440/80R28			DUO262	DUO262V				
30" RIMS	14.9-30		DUO252	DUO252V				
	16.9-30		DUO266	DUO266V			SDU16930916-58	
	18.4-30		DUO271	DUO271V	DUO271S			
	23.1-30		DUO281	DUO281V	DUO281S			
	380/85R30		DUO252	DUO252V				
	420/85R30		DUO266	DUO266V			SDU16930916-58	
	480/80R30		DUO271	DUO271V	DUO271S			
30.5" - 34" RIMS	750/60R30.5	2656C-2	2656CV-10-2		2956SHP	2956NSG	NLS750 DDS750	
	9.5-32			DUO226	DUO226V			
	11.2R32			DUO218	DUO218V			
	30.5L-32			DUO283	DUO283V		NLS305 DDS305	
	270/95R32			DUO218	DUO218V			
	11.2-34			DUO224	DUO224V			
	16.9-34			DUO266	DUO266V			
	18.4-34			DUO273	DUO273V	DUO273S	2935RNSG-10	SDU18434
	20.8-34			DUO272	DUO272V	DUO272S		
	23.1-34			DUO282	DUO282V			
	420/85R34			DUO266	DUO266V			
	460/85R34			DUO273	DUO273V	DUO273S	2935RNSG-10	SDU18434
	480/80R34			DUO273	DUO273V	DUO273S	2935RNSG-10	SDU18434

AGRICULTURE / UTILITY

TIRE SIZE	REGULAR TWIST LINK	V-BAR	TWIST LINK ALLOY PATTERN		NORDIC™ STUDDED ALLOY H-PATTERN	NORDIC™ SUPER GRIP PATTERN	NORDIC™ STUDDED NET-LINK
	PAGE 31		REGTWIST LINK	V-BAR	PAGE 34	PAGE 57	PAGE 42
	PAGE 31		PAGE 56		PAGE 34	PAGE 57	PAGE 42
36" - 40" RIMS	11.2-36		DUO224	DUO224V			
	12.4-36		DUO232	DUO232V			
	13.6-36		DUO246	DUO246V			
	13.9-36		DUO246	DUO246V			
	11.2-38		DUO232	DUO232V			
	12.4-38		DUO232	DUO232V			
	13.6-38		DUO246	DUO246V			
	14.9-38		DUO254	DUO254V			
	15.5-38		DUO266	DUO266V			
	16.9-38		DUO270	DUO270V			
	18.4-38		DUO272	DUO272V	DUO272S	2938RNSG-10	
	20.8-38		DUO276	DUO276V	DUO276S	2943RNSG-10	
	320/85R38		DUO232	DUO232V			
	340/85R38		DUO246	DUO246V			
	380/80R38		DUO254	DUO254V			
	420/85R38		DUO270	DUO270V			
	460/85R38		DUO272	DUO272V	DUO272S	2938RNSG-10	
	480/80R38		DUO272	DUO272V	DUO272S	2938RNSG-10	
	520/85R38		DUO276	DUO276V	DUO276S	2943RNSG-10	
	710/70R38						DDU710703834
9.5-40		DUO228	DUO228V				
230/95R40		DUO228	DUO228V				
42" - 44" RIMS	12.4-42		DUO246	DUO246V			
	18.4-42		DUO277	DUO277V			
	20.8-42		DUO285	DUO285V			
	320/90R42		DUO246	DUO246V			
	480/80R42		DUO277	DUO277V			
	520/85R42		DUO285	DUO285V			
	8.3-44		DUO228	DUO228V			
	9.5-44		DUO227	DUO227V			
	11.2-44		DUO236	DUO236V			
	210/95R44		DUO228	DUO228V			
	230/95R44		DUO227	DUO227V			
	270/95R44		DUO236	DUO236V			
46" RIMS	12.4-46		DUO248	DUO248V			
	14.9-46		DUO256	DUO256V			
	18.4-46		DUO277	DUO277V			
	320/90R46		DUO248	DUO248V			
	380/90R46		DUO256	DUO256V			

Copyright © 2021 OCCANADA

AGRICULTURE / UTILITY

TIRE SIZE	REGULAR TWIST LINK	V-BAR	TWIST LINK ALLOY PATTERN		NORDIC™ STUDDED ALLOY H-PATTERN	NORDIC™ SUPER GRIP PATTERN	NORDIC™ STUDDED NET-LINK
	PAGE 31		REGTWIST LINK	V-BAR	PAGE 34		PAGE 57
		PAGE 56					
46" - 54" RIMS	480/80R46		DUO277	DUO277V			
	9.5-48		DUO236	DUO236V			
	11.2-48		DUO247	DUO247V			
	12.4-48		DUO259	DUO259V			
	230/95R48		DUO236	DUO236V			
	270/95R48		DUO247	DUO247V			
	12.4-52		DUO259	DUO259V			
	300/95R52		DUO259	DUO259V			
	12.4-54		DUO261	DUO261V			
	320/90R54		DUO261	DUO261V			



DUO-GRIP TWIST LINK

10mm cross patterns and 8mm side chains.
Case hardened alloy steel twist link. Ideal for tractors or deep lug tires, patterns keep chains from settling below lugs and give continual traction.



DUO-GRIP V-BAR

10mm cross patterns and 8mm side chains.
Case hardened alloy steel V-Bar. Ideal for tractors or deep lug tires, patterns keep chains from settling below lugs and give continual traction. V-Bar reinforced patterns provide excellent additional traction.



ACCESSORIES



All spider tensioners and adjusters sold separately

Ask about our Nordic™ Studded options!

DUO-GRIP TWIST LINK				DUO-GRIP V-BAR			
PART #	WEIGHT / PAIR	CROSS PATTERN	TENSIONER	PART #	WEIGHT / PAIR	CROSS PATTERN	TENSIONER
DUO210	45 Kg (100 lbs)	DUO293BC	0218	DUO210V	59 Kg (130 lbs)	DUO293BCV	0218
DUO214	45 Kg (100 lbs)	DUO292BC		DUO214V	56 Kg (123 lbs)	DUO292BCV	
DUO218	63 Kg (139 lbs)	DUO293BC		DUO218V	74 Kg (163 lbs)	DUO293BCV	
DUO224	70 Kg (154 lbs)	DUO292BC		DUO224V	84 Kg (185 lbs)	DUO292BCV	
DUO226	52 Kg (114 lbs)	DUO292BC		DUO226V	62 Kg (137 lbs)	DUO292BCV	
DUO227	80 Kg (176 lbs)	DUO292BC		DUO227V	96 Kg (211 lbs)	DUO292BCV	
DUO228	70 Kg (155 lbs)	DUO292BC		DUO228V	84 Kg (186 lbs)	DUO292BCV	
DUO229	63 Kg (138 lbs)	DUO293BC		DUO229V	75 Kg (166 lbs)	DUO293BCV	
DUO232	77 Kg (169 lbs)	DUO293BC		DUO232V	92 Kg (203 lbs)	DUO293BCV	
DUO236	92 Kg (203 lbs)	DUO293BC		DUO236V	111 Kg (244 lbs)	DUO293BCV	
DUO238	57 Kg (125 lbs)	DUO295BC		DUO238V	69 Kg (152 lbs)	DUO295BCV	
DUO239	61 Kg (135 lbs)	DUO295BC		DUO239V	73 Kg (162 lbs)	DUO295BCV	
DUO240	68 Kg (150 lbs)	DUO295BC		DUO240V	82 Kg (180 lbs)	DUO295BCV	
DUO241	59 Kg (130 lbs)	DUO294BC	DUO241V	97 Kg (156 lbs)	DUO294BCV		
DUO242	64 Kg (141 lbs)	DUO294BC	DUO242V	78 Kg (172 lbs)	DUO294BCV		
DUO243	49 Kg (108 lbs)	DUO297BC	DUO243V	53 Kg (117 lbs)	DUO297BCV		
DUO246	81 Kg (178 lbs)	DUO294BC	DUO246V	97 Kg (214 lbs)	DUO294BCV		
DUO247	89 Kg (197 lbs)	DUO294BC	0220	DUO247V	107 Kg (236 lbs)	DUO294BCV	0220
DUO248	98 Kg (216 lbs)	DUO297BC		DUO248V	118 Kg (259 lbs)	DUO297BCV	
DUO250	70 Kg (155 lbs)	DUO295BC		DUO250V	81 Kg (178 lbs)	DUO295BCV	
DUO252	83 Kg (182 lbs)	DUO295BC		DUO252V	99 Kg (218 lbs)	DUO295BCV	
DUO254	84 Kg (187 lbs)	DUO296BC		DUO254V	102 Kg (224 lbs)	DUO296BCV	
DUO256	108 Kg (237 lbs)	DUO297BC		DUO256V	129 Kg (284 lbs)	DUO297BCV	
DUO259	115 Kg (254 lbs)	DUO297BC		DUO259V	138 Kg (305 lbs)	DUO297BCV	
DUO260	65 Kg (143 lbs)	DUO297BC		DUO260V	69 Kg (152 lbs)	DUO297BCV	
DUO261	123 Kg (270 lbs)	DUO297BC		DUO261V	147 Kg (324 lbs)	DUO297BCV	
DUO262	70 Kg (154 lbs)	DUO297BC		DUO262V	87 Kg (192 lbs)	DUO297BCV	
DUO264	53 Kg (118 lbs)	DUO298BC		DUO264V	57 Kg (127 lbs)	DUO298BCV	
DUO265	65 Kg (143 lbs)	DUO298BC		DUO265V	73 Kg (161 lbs)	DUO297BCV	
DUO266	82 Kg (181 lbs)	DUO297BC		DUO266V	96 Kg (211 lbs)	DUO297BCV	
DUO268	69 Kg (152 lbs)	DUO298BC	DUO268V	73 Kg (161 lbs)	DUO298BCV		
DUO270	91 Kg (200 lbs)	DUO297BC	DUO270V	109 Kg (240 lbs)	DUO297BCV		
DUO271	83 Kg (182 lbs)	DUO298BC	DUO271V	100 Kg (220 lbs)	DUO298BCV		
DUO272	87 Kg (192 lbs)	DUO298BC	DUO272V	154 Kg (340 lbs)	DUO298BCV		
DUO273	92 Kg (203 lbs)	DUO298BC	0294	DUO273V	115 Kg (253 lbs)	DUO298BCV	0294
DUO276	118 Kg (260 lbs)	DUO299BC		DUO276V	139 Kg (306 lbs)	DUO299BCV	
DUO277	119 Kg (263 lbs)	DUO298BC		DUO277V	143 Kg (316 lbs)	DUO298BCV	
DUO280	96 Kg (211 lbs)	DUO299BC		DUO280V	114 Kg (253 lbs)	DUO299BCV	
DUO281	109 Kg (239 lbs)	DUO299BC		DUO281V	130 Kg (287 lbs)	DUO299BCV	
DUO282	118 Kg (261 lbs)	DUO301BC		DUO282V	142 Kg (313 lbs)	DUO301BCV	
DUO283	138 Kg (304 lbs)	DUO301BC		DUO283V	166 Kg (365 lbs)	DUO301BCV	
DUO285	135 Kg (298 lbs)	DUO301BC		DUO285V	162 Kg (358 lbs)	DUO301BCV	

NORDIC™ SUPER GRIP STUDDED

10mm cross patterns. Best for aggressive off-road applications. Hardened alloy steel throughout for maximum life. Continuous pattern provides excellent traction in all directions for studs to dig into terrain.

PART #	MATERIAL SIZE	WEIGHT / PAIR	ADJUSTER
2910RNSG-10	10mm	95 Kg (209 lbs)	0294
2912RNSG-10	10mm	98 Kg (217 lbs)	
2918RNSG-10	10mm	98 Kg (217 lbs)	
2925RNSG-10	10mm	106 Kg (233 lbs)	0296
2926RNSG-8	8mm	91 Kg (200 lbs)	
2930RNSG-8	8mm	100 Kg (220 lbs)	
2935RNSG-10	10mm	135 Kg (297 lbs)	
2938RNSG-10	10mm	156 Kg (345 lbs)	
2941RNSG-10	10mm	116 Kg (255 lbs)	
2943RNSG-10	10mm	193 Kg (426 lbs)	
2951RNSG-10	10mm	128 Kg (283 lbs)	

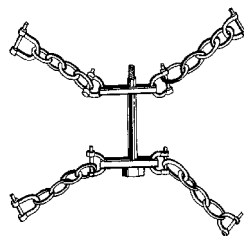

0294 & 0296
Adjusters sold separately

ATV / UTV

TIRE SIZE	V-BAR DOUBLE DUTY	V-BAR PATTERN	S.I.T.S.
	PAGE 53	PAGE 53	PAGE 56
14.5X7.00-6	1715HDV-2	HP1715V	11 - 15MM
145/70-6	1715HDV-2	HP1715V	
16X8.00-7		Call for sizing	
18X8.50-8	1724HDV-2	ATV-234 HP1724HDV	
19X7.00-8		Call for sizing	
19X8.00-8		Call for sizing	
20X7.00-8		Call for sizing	
20X10.00-8	1733HDV-2	ATV-362 HP1733HDV	
21X10.00-8	ATV-A-2	ATV-335	
AT22X9-8	ATV-A-2		
22X10.00-8	ATV-A-2	ATV-335	
22X11.00-8	ATV-A-2	ATV-335	
AT18X10-9		Call for sizing	
AT20X10-9	ATV-A-2	ATV-362	
AT20X11.00-9		Call for sizing	
21X10-9		ATV-335	
AT22X10.00-9	ATV-A-2	ATV-335	
AT22X11.00-9	ATV-A-2	ATV-335	
AT25X11-9	ATV-B-2	ATV-424	
25X12.00-9	ATV-C-2	ATV-415	
25X12.50-9		ATV-415	
AT25X13.00-9		Call for sizing	
AT25X13.50-9		ATV-418	
20.5X8.00-10		Call for sizing	
AT21X10-10		ATV-335	
AT22X7.00-10	ATV-A-2		
22X9.00-10	ATV-A-2		
22X10.00-10	ATV-A-2 1736HDV-2	ATV-335 HP1736HDV	
22X11.00-10	ATV-B-2	ATV-335	
AT23X7.00-10		ATV-362	
AT23X8.00-10	ATV-A-2	ATV-335	
AT23X10.00-10	ATV-A-2	ATV-362	
23X11.00-10	ATV-C-2		
AT24X11.00-10	ATV-C-2	ATV-382	
AT24X11.50-10	ATV-C-2	ATV-382	
25X11.00-10	ATV-C-2	ATV-424	
25X12.00-10	ATV-C-2	ATV-415	
AT23X8.00-11	ATV-A-2	ATV-335	
23X9.00-11		ATV-335	
23.5X8.00-11		ATV-335	
AT24X8.00-11	ATV-A-2	ATV-335	
AT24X9.00-11	ATV-B-2	ATV-335	

CHOOSING
THE CORRECT SIZE
DEPENDS ON TIRE
THREAD DEPTH

11 - 15MM

15MM - 18MM

TIRE SIZE	V-BAR DOUBLE DUTY	V-BAR PATTERN	S.I.T.S.
	PAGE 53	PAGE 53	PAGE 56
AT24X10.00-11	ATV-C-2	ATV-382	15MM - 18MM
25X10.00-11	ATV-C-2	ATV-424	
185/88-12		ATV-335	
205/80R12	ATV-C-2	ATV-335	
23X8.50-12	1742HDV-2	ATV-335 HP1742HDV	
23X10.00-12	ATV-A-2	ATV-335	
23X10.50-12	1736HDV-2	ATV-335	
24X8.00-12		ATV-335	
24X9.00-12	ATV-B-2	ATV-362	
24X10.00-12	ATV-C-2	ATV-382	
24X11.00-12	ATV-B-2	ATV-382	
24X12.00-12	ATV-C-2 1745HDV-2	HP1745HDV	CHOOSING THE CORRECT SIZE DEPENDS ON TIRE THREAD DEPTH
25X8.00-12	ATV-B-2	ATV-335	
25X10.00-12	ATV-C-2	ATV-382	
25X11.00-12	ATV-C-2		
26X8.00-12		ATV-335	
26X9.00-12		ATV-382	
26X10.00-12	ATV-C-2	ATV-486	
26X10.50-12	ATV-C-2	ATV-461	
26X11.00-12	ATV-D-2	ATV-486	
26X12.00-12	1748HDV-2	ATV-461 HP1748HDV	
27X9.00-12		ATV-461	
AT27X10.00-12		ATV-486	
27X11.00-12		ATV-461	
27X12.00-12		ATV-483 HP1751HDV	
270/60R12		ATV-382	
28X9-12		ATV-424	
28X10.00-12		ATV-486	
28X12.00-12		ATV-483	
29.5X10.00-12		ATV-483	
26X8.00-14		ATV-424	
27X11.00-14		ATV-461	
27X10.00-15		ATV-461	
27X10.50-15	1748HDV-2 1500V-2	ATV-461 HP1748HDV	

18MM



ATV / UTV

V-BAR

5.5mm cross chains. V-Bar reinforced for excellent traction in ice, snow and mud. Available in Double Duty 2 link spacing (-2) or Single Duty 4 link spacing. Double Duty offers more coverage, better continual traction and a smoother ride.



PART #	WEIGHT / PAIR	CROSS CHAIN
ATV-A-2	10 Kg (21 lbs)	5824
ATV-B-2	11 Kg (23 lbs)	
ATV-C-2	14 Kg (30 lbs)	5825
ATV-D-2	16 Kg (35 lbs)	

ACCESSORIES



All spider tensioners sold separately



7300HD

Chain Pliers sold separately

V-BAR GRIPPER PATTERN

5.5mm cross patterns. Carbon steel reinforced V-Bar in a diamond pattern. This superior chain offers excellent lateral traction in ice, snow, and mud. The V-Bar Gripper also provides a smoother ride due to the continual pattern.



ACCESSORIES



All spider tensioners sold separately

PART #	WEIGHT / PAIR
ATV-234	11 Kg (24 lbs)
ATV-335	15 Kg (33 lbs)
ATV-362	15 Kg (32 lbs)
ATV-382	16 Kg (35 lbs)
ATV-415	16 Kg (34 lbs)
ATV-418	16 Kg (35 lbs)
ATV-424	17 Kg (38 lbs)
ATV-461	18 Kg (40 lbs)
ATV-483	18 Kg (40 lbs)
ATV-486	17 Kg (36 lbs)



SCREW IN TRACTION STUDS

PART #	SIZE (OAL)	QUANTITY / BAG	S.I.T.S. TOOL
SITS-11-BAG	11mm (0.43")	100	SITS-SMT
SITS-15-BAG	15mm (0.59")	100	SITS-MMT
SITS-18-BAG	18mm (0.70")	100	SITS-MMT
SITS-25-BAG	25mm (0.98")	100	SITS-MMT
SITS-30-BAG	30mm (1.18")	100	SITS-LMT
SITS-35-BAG	35mm (1.37")	250	SITS-XLMT

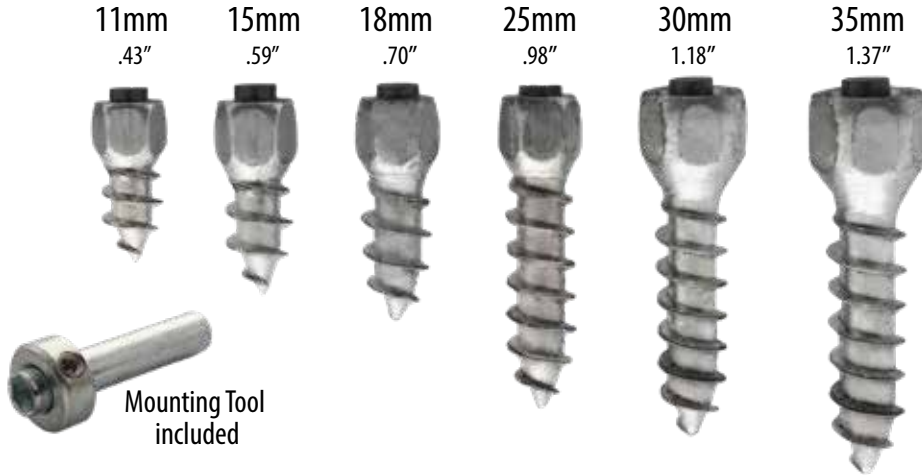
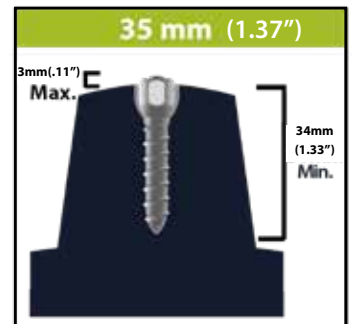
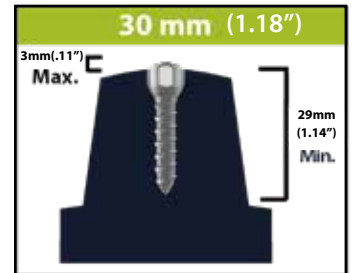
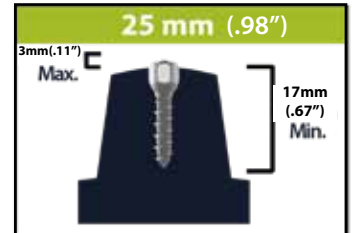
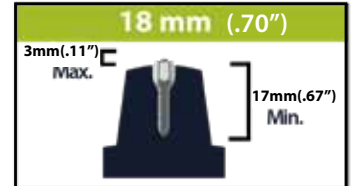
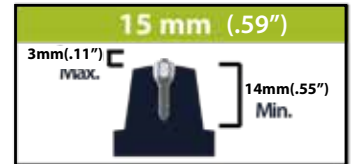

VEHICLE TYPE	11mm (.43")	15mm (.59")	18mm (.70")	25mm (.98")	30mm (1.18")	35mm (1.37")	RECOMMENDED PIECES / TIRE
A.T.V.	+	+	+				50 - 75
GARDEN TRACTOR / SNOWBLOWER	+	+					50 - 75
FORKLIFT		+	+	+			50 - 100
SKID STEER		+	+				50 - 100
SMALL LOADER		+	+				75 - 100
TRACTOR		+	+	+	+		100 - 150
LOADER			+	+	+	+	100 - 150



Contact us at www.qccanada.com for proper installation and use of Screw In Traction Studs.



ACCESSORIES

REPLACEMENT CROSS CHAINS



Cross chain length is measured from bearing point to bearing point (as shown)

PART #	CROSS CHAIN TYPE	BULK MATERIAL PART #	QTY OF CROSS CHAINS / BAG	WEIGHT / BAG	CROSS CHAIN SIZE		LINKS / CROSS CHAIN	INSIDE LENGTH W/ C.C. HOOKS	CROSS CHAIN HOOK	CROSS CHAIN HOOK SIZE	
					lbs	mm				in	mm
5411	TWIST	30177	25	4	4.5	11/64	4	6.84	20177	4.5	11/64
5412	TWIST	30177	25	4	4.5	11/64	5	8.02	20177	4.5	11/64
5414	TWIST	30177	25	5	4.5	11/64	7	10.38	20177	4.5	11/64
5419	TWIST	30177	25	6	4.5	11/64	8	11.56	20177	4.5	11/64
5420	TWIST	30177	25	7	4.5	11/64	9	12.88	20177	4.5	11/64
5422	TWIST	30177	25	7	4.5	11/64	10	13.88	20177	4.5	11/64
5423	TWIST	30177	25	10	4.5	11/64	11	14.98	20177	4.5	11/64
5425	TWIST	30177	25	9	4.5	11/64	13	17	20208S	5.2	13/64
5814	V-BAR	38207	25	8	5.2	13/64	7	10.18	20208S	5.2	13/64
5820	V-BAR	38207	25	9	5.2	13/64	9	12.02	20208S	5.2	13/64
5822	V-BAR	38207	25	12	5.2	13/64	10	12.94	20208S	5.2	13/64
5824	V-BAR	38207	25	13	5.2	13/64	11	14.38	20208S	5.2	13/64
5825	V-BAR	38207	25	15	5.2	13/64	13	16.38	20208S	5.2	13/64
6216	TWIST	30218	25	11	5.5	7/32	6	9.13	20250	6.4	1/4
6218	TWIST	30218	25	12	5.5	7/32	8	11.13	20250	6.4	1/4
6219	TWIST	30218	25	12	5.5	7/32	9	12.25	20250	6.4	1/4
6221	TWIST	30218	25	12	5.5	7/32	10	13	20250	6.4	1/4
6221SL	SQUARE	31218	25	19	5.5	7/32	11	14.5	20250	6.4	1/4
6225	TWIST	30218	25	14	5.5	7/32	12	15.38	20250	6.4	1/4
6225SL	SQUARE	31218	25	17	5.5	7/32	13	16.25	20250	6.4	1/4
6229HP	TWIST HP	N/A	25	31	5.5	7/32	14	17	20312	8	5/16
6233	TWIST	30312	25	23	8	5/16	9	16.01	20312	8	5/16
6248	TWIST	30281	25	22	7	9/32	8	13	20312	8	5/16
6248SL	SQUARE	31281	25	22	7	9/32	8	11.75	A20312LW	8	5/16
6250SL	SQUARE	31281	25	23	7	9/32	9	14.75	A20312LW	8	5/16
6251	TWIST	30281	25	23	7	9/32	9	14.38	20312	8	5/16
6251SL	SQUARE	31281	25	34	7	9/32	9	15.63	20375	10	3/8
6253	TWIST	30281	25	25	7	9/32	10	15.88	20312	8	5/16
6253SL	SQUARE	31281	25	28	7	9/32	11	17.38	20375	10	3/8
6255	TWIST	30312	25	28	8	5/16	7	13.25	20375	10	3/8
6255SL	SQUARE	31312	25	42	8	5/16	7	12.5	A20344H	9	11/32
6256	TWIST	30312	25	30	8	5/16	8	15	20375	10	3/8
6258	TWIST	30281	25	25	7	9/32	11	17.25	20375	10	3/8
6258HP	TWIST HP	N/A			7	9/32	12	18.88	20344	9	11/32
6259	TWIST	30281	25	27	7	9/32	12	18.13	20312	8	5/16

ACCESSORIES

PART #	CROSS CHAIN TYPE	BULK MATERIAL PART #	QTY OF CROSS CHAINS / BAG	WEIGHT / BAG	CROSS CHAIN SIZE		LINKS / CROSS CHAIN	INSIDE LENGTH W/ C.C. HOOKS	CROSS CHAIN HOOK	CROSS CHAIN HOOK SIZE	
				lbs	mm	in		in		mm	in
6259SL	SQUARE	31281	25	39	7	9/32	13	19.88	A20312LW	8	5/16
6260	TWIST	30312	25	34	8	5/16	9	16.25	20375	10	3/8
6260SL	SQUARE	31312	25	44	8	5/16	9	15.38	20375	10	3/8
6263	TWIST	30312	25	40	8	5/16	10	17.63	20375	10	3/8
6263SL	SQUARE	31312	25	46	8	5/16	11	18.38	20375	10	3/8
6265	TWIST	30281	25	39	7	9/32	16	23.12	20375	10	3/8
6266	TWIST	30312	25	36	8	5/16	11	18.79	20375	10	3/8
6267	TWIST	30281	25	35	7	9/32	17	24.88	20375	10	3/8
6268	TWIST	30312	25	39	8	5/16	12	20.75	20375	10	3/8
6268SL	SQUARE	31312	25	54	8	5/16	13	21.13	20375	10	3/8
6270SL	SQUARE	31312	25	55	8	5/16	15	24.25	A20393H	10	3/8
6434HH	TWIST	30375	25	57	10	3/8	11	17.38	20406	10.3	13/32
6436	TWIST	30375	25	57	10	3/8	12	18.75	20406	10.3	13/32
6438	TWIST	30375	25	61	10	3/8	13	20	20406	10.3	13/32
6445	TWIST	30375	25	66	10	3/8	14	21.25	20406	10.3	13/32
E6530S	SQUARE	31375	5	17	10	3/8	17	26.38	A20437H	11	7/16
E6535SH	SQUARE	31437	5	30	11	7/16	15	29.38	A20531H	13	1/2
E6540SH	SQUARE	31437	5	31	11	7/16	17	32.25	A20531H	13	1/2
E6550SH	SQUARE	31437	5	33	11	7/16	19	34.75	A20531H	13	1/2
E6560SH	SQUARE	31531	5	51	13	1/2	21	39.38	A20531H	13	1/2
E6570SH	SQUARE	31531	5	69	13	1/2	25	45.38	A20531H	13	1/2
E6580SH	SQUARE	31531	5	84	13	1/2	29	52.25	A20531H	13	1/2
6630	TWIST	30375	10	31	10	3/8	17	25.25	20406	10.3	13/32
6640	TWIST	30437	10	44	11	7/16	15	28.5	20437	11	7/16
6650	TWIST	30437	10	53	11	7/16	19	34.4	20437	11	7/16
6650HD	TWIST	30531	5	47	13	1/2	16	34.25	20531	13	1/2
6660	TWIST	30531	5	48	13	1/2	19	39	20531	13	1/2
6670	TWIST	30531	5	54	13	1/2	22	45.13	20531	13	1/2
6680	TWIST	30531	5	63	13	1/2	26	52.5	20531	13	1/2
6818	V-BAR	38218	25	13	5.5	7/32	8	11.12	20250	6.4	1/4
6819	V-BAR	38218	25	15	5.5	7/32	9	12.25	20250	6.4	1/4
6821	V-BAR	38218	25	17	5.5	7/32	10	13.13	20250	6.4	1/4
6822	V-BAR	38281	25	28	7	9/32	9	14.37	20312	8	5/16
6823	V-BAR	38218	25	17	5.5	7/32	11	14.08	20250	6.4	1/4
6825	V-BAR	38218	25	20	5.5	7/32	12	15	20250	6.4	1/4
6827	V-BAR	38218	25	21	5.5	7/32	14	17.63	20250	6.4	1/4
6828	V-BAR	38218	25	22	5.5	7/32	19	22.63	20250	6.4	1/4
6829HP	V-BAR HP	N/A			5.5	7/32	14	17	20312	8	5/16
6830	V-BAR	38375	10	34	10	3/8	17	25	20406	10.3	13/32
6840	V-BAR	38375	10	36	10	3/8	19	27.43	20406	10.3	13/32
6848	V-BAR	38281	25	27	7	9/32	8	13	20312	8	5/16
6853	V-BAR	38281	25	28	7	9/32	10	15.75	20312	8	5/16
6853L	V-BAR	38218			6	1/4	13	16	20250	6.4	1/4
6858	V-BAR	38281	25	25	7	9/32	11	17.25	20375	10	3/8
6858HP	V-BAR HP	N/A			7	9/32	12	18.25	20344	9	11/32
6860	V-BAR	38312	25	42	8	5/16	9	16.38	20375	10	3/8
6869	V-BAR	38312			8	5/16	13	21.75	20375	10	3/8

ACCESSORIES

PART #	CROSS CHAIN TYPE	BULK MATERIAL PART #	QTY OF CROSS CHAINS / BAG	WEIGHT / BAG	CROSS CHAIN SIZE		LINKS / CROSS CHAIN	INSIDE LENGTH W/ C.C. HOOKS	CROSS CHAIN HOOK	CROSS CHAIN HOOK SIZE	
				lbs	mm	in		in		mm	in
6912	STUD	39281	25	28	7	9/32	10	15.13	A20344H	9	11/32
6912L	STUD	39281	25	28	7	9/32	10	15.2	A20312LW	8	5/16
6913	STUD	39281	25	30	7	9/32	11	16.13	A20344H	9	11/32
6913L	STUD	39281	25	30	7	9/32	11	16.38	A20312LW	8	5/16
6914	STUD	39281	25	32	7	9/32	12	17.5	A20344H	9	11/32
6914L	STUD	39281	25	32	7	9/32	12	17.5	A20312LW	8	5/16
6915	STUD	39281	25	34	7	9/32	13	18.63	A20344H	9	11/32
6915L	STUD	39281	25	34	7	9/32	13	18.25	A20312LW	8	5/16
6916L	STUD	39281	25	35	7	9/32	14	19.75	A20312LW	8	5/16
6918L	STUD	39281	25	39	7	9/32	16	22.2	A20312LW	8	5/16
6920L	STUD	39281	25	41	7	9/32	18	23.75	A20312LW	8	5/16
6922	STUD	39312	25	43	8	5/16	10	16	A20393H	10	3/8
6923	STUD	39312	25	42	8	5/16	11	17.13	A20393H	10	3/8
6924	STUD	39312	25	44	8	5/16	12	18.13	A20393H	10	3/8
6925	STUD	39312	25	51	8	5/16	13	19.38	A20393H	10	3/8
6926	STUD	39312	25	57	8	5/16	14	20.63	A20393H	10	3/8
6927	STUD	39375	10	27	10	3/8	9	19	A20437H	11	7/16
6928	STUD	39375	10	29	10	3/8	10	20.88	A20437H	11	7/16
6929	STUD	39375	10	34	10	3/8	12	23.5	A20437H	11	7/16
6930	STUD	39375	10	38	10	3/8	14	27.13	A20437H	11	7/16
6931	STUD	39312	10	28	8	5/16	16	23	A20393H	10	3/8
6932	STUD	39312	10	30	8	5/16	18	25.13	A20393H	10	3/8
6935	STUD	39375	10	32	10	3/8	18	33.13	A20437H	11	7/16
6940	STUD	39437	10	45	11	7/16	15	29.75	A20531H	13	1/2
6950	STUD	39437	10	67	11	7/16	19	36.88	A20531H	13	1/2
6951	STUD	39531			13	1/2	10	25.75	A20531H	13	1/2
6955	STUD	39531			13	1/2	15	36	A20531H	13	1/2
6960	STUD	39531	5	53	13	1/2	17	39.11	A20531H	13	1/2
6970	STUD	39531	5	58	13	1/2	19	44.38	A20531H	13	1/2
6980	STUD	39531	5	68	13	1/2	23	51.88	A20531H	13	1/2
7213	TWIST	30312	25	43	8	5/16	13	21.63	20375	10	3/8
7213SL	SQUARE	31312	25	54	8	5/16	13	21.13	20375	10	3/8
7214	TWIST	30312	25	45	8	5/16	14	22.96	20375	10	3/8
7215	TWIST	30312	25	48	8	5/16	15	24.13	20375	10	3/8
7215SL	SQUARE	31312	25	48	8	5/16	17	26.25	20375	10	3/8
7216	TWIST	30312	25	60	8	5/16	20	31.3	20375	10	3/8
7419SL	SQUARE	31375	10	31	10	3/8	13	21.63	A20437H	11	7/16
7420	TWIST	30375	10	29	10	3/8	16	23.66	20406	10.3	13/32
7426	TWIST	30375	10	33	10	3/8	19	27.44	20406	10.3	13/32
8500	STUD HP	N/A			8	5/16	14	20.25	A20393H	10	3/8
8502	STUD HP	N/A			10	3/8	16	29.75	A20437H	11	7/16
8503	STUD HP	N/A			11	7/16	15	28.7	A20531H	13	1/2
8504	STUD HP	N/A			11	7/16	17	32.9	A20531H	13	1/2
8505	STUD HP	N/A			11	7/16	19	36.1	A20531H	13	1/2
8506	STUD HP	N/A			11	7/16	21	39.3	A20531H	13	1/2
8507	STUD HP	N/A			13	1/2	15	35.6	A20531H	13	1/2
8508	STUD HP	N/A			13	1/2	17	39.6	A20531H	13	1/2







ACCESSORIES

PART #	CROSS CHAIN TYPE	BULK MATERIAL PART #	QTY OF CROSS CHAINS / BAG	WEIGHT / BAG	CROSS CHAIN SIZE		LINKS / CROSS CHAIN	INSIDE LENGTH W/ C.C. HOOKS	CROSS CHAIN HOOK	CROSS CHAIN HOOK SIZE	
				lbs	mm	in		in		mm	in
8509	STUD HP	N/A			13	1/2	19	43.6	A20531H	13	1/2
8511	STUD HP	N/A			13	1/2	21	47.6	A20531H	13	1/2
8512	STUD HP	N/A			13	1/2	13	31.6	A20531H	13	1/2
8513	STUD HP	N/A			13	1/2	11	27.6	A20531H	13	1/2
8514	STUD HP	N/A			10	3/8	20	36	A20437H	11	7/16
DUO292	TWIST	N/A			10	3/8	9	18.25	20406	10.3	13/32
DUO292V	V-BAR	N/A			10	3/8	9	18.25	20406	10.3	13/32
DUO293	TWIST	N/A			10	3/8	10	20	20406	10.3	13/32
DUO293V	V-BAR	N/A			10	3/8	10	20	20406	10.3	13/32
DUO294	TWIST	N/A			10	3/8	11	22	20406	10.3	13/32
DUO294V	V-BAR	N/A			10	3/8	11	22	20406	10.3	13/32
DUO295	TWIST	N/A			10	3/8	12	23.3	20406	10.3	13/32
DUO295V	V-BAR	N/A			10	3/8	12	23.3	20406	10.3	13/32
DUO296	TWIST	N/A			10	3/8	13	25.25	20406	10.3	13/32
DUO296V	V-BAR	N/A			10	3/8	13	25.25	20406	10.3	13/32
DUO297	TWIST	N/A			10	3/8	14	27	20406	10.3	13/32
DUO297V	V-BAR	N/A			10	3/8	14	27	20406	10.3	13/32
DUO298	TWIST	N/A			10	3/8	17	31.5	20406	10.3	13/32
DUO298V	V-BAR	N/A			10	3/8	17	31.5	20406	10.3	13/32
DUO299	TWIST	N/A			10	3/8	19	35.25	20406	10.3	13/32
DUO299V	V-BAR	N/A			10	3/8	19	35.25	20406	10.3	13/32
DUO301	TWIST	N/A			10	3/8	21	39.5	20406	10.3	13/32
DUO301V	V-BAR	N/A			10	3/8	21	39.5	20406	10.3	13/32
V5315	V-BAR	38281	25	30	7	9/32	9	14.88	20375	10	3/8
V5315L	V-BAR	38250			6	1/4	12	15.13	A20312LW	8	5/16
V5330	V-BAR	38281	25	35	7	9/32	11	17.38	20375	10	3/8
V5340	V-BAR	38281	25	38	7	9/32	12	18.75	20375	10	3/8
V5340HD	V-BAR	38312	25	43	8	5/16	11	18.63	20375	10	3/8
V5340HDCON	V-BAR	38312	25	40	8	5/16	10	17.38	20375	10	3/8
V5340L	V-BAR	38250			6	1/4	16	19	A20312LW	8	5/16
V5355	V-BAR	38312	25	44	8	5/16	12	20.13	20375	10	3/8
V5370	V-BAR	38312	25	50	8	5/16	14	23.25	20375	10	3/8
V5415	V-BAR	38281	25	38	7	9/32	17	24.5	20375	10	3/8
V5430	V-BAR	38281	25	44	7	9/32	19	26.88	20375	10	3/8
V5440	V-BAR	38281	25	51	7	9/32	21	29.13	20375	10	3/8

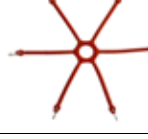
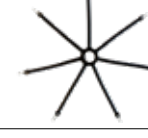
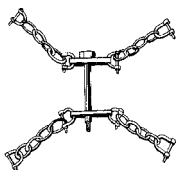
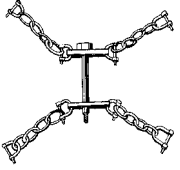

Copy write 2023 OCCANADA

ACCESSORIES

PRODUCT	APPLICATION	PART #	WEIGHT / PAIR	PAIRS PER CASE	
Spider tensioners assist in ensuring a secure fit for your tire chains and reduces the chance of vehicle damage.					
	Passenger	0212	0.45 Kg (1 lb)	30	
	Passenger / ATV / Garden Tractor / Forklift	0213	0.45 Kg (1 lb)	30	
	Light Truck	0216	0.45 Kg (1 lb)	30	
	Light Truck	0217	0.68 Kg (1.5 lbs)	30	
	Medium Truck	0218	0.81 Kg (1.8 lbs)	30	
	Small Loader / Tractor	0220	1.36 Kg (3 lbs)	20	
Chain adjusters for heavy chain applications					
	Single Bolt Link & Shackle	51 - 61cm 20" - 24"	0294	4.5 Kg (10 lbs)	1 Pair
	Single Bolt Link & Shackle	63 - 81cm 25" - 32"	0296	5.4 Kg (12 lbs)	1 Pair
HD Chain Tightener for heavy chain applications					
	Heavy Duty screw actuated chain tightening tool	2506HD	6.8 Kg (15 lbs)	1 Each	

Contact QCCanada for product information or application questions. 1-888-507-9734 info@qccanada.com

ACCESSORIES

PART #	DESCRIPTION	APPLICATION	HANDLE LENGTH	WEIGHT / PIECE	PRODUCT
CHAIN PLIERS					
7300HD	Medium HD	Passenger Car & Light Truck	35cm (14")	0.5 Kg (1 lb)	
7502S	Medium Handle	All Truck & Tractor	45cm (18")	2.3 Kg (5 lbs)	
7302-2	Long Handle	All Truck & Tractor	91cm (36")	3.2 Kg (7 lbs)	
CHAIN / BOLT CUTTERS					
BC18	Medium Handle	Passenger Car	45cm (18")	2.3 Kg (5 lbs)	
BC30	Long Handle	Truck	76cm (30")	3.6 Kg (8 lbs)	
BC36	Long Handle	Off-Road	91cm (36")	5.4 Kg (12 lbs)	

ACCESSORIES

REGULAR TWIST LINK

CARBON & ALLOY STEEL,
ROUND WIRE



LINK MATERIAL SIZE			CARBON - BAG QUANTITY			CARBON - DRUM QUANTITY			ALLOY - BAG QUANTITY		
mm	Inches	Gauge	Part #	Length / Bag	Weight / Bag	Part #	Length / Drum	Weight / Drum	Part #	Length / Bag	Weight / Bag
4.8	3/16	0.192	30177	30m (100')	11 Kg (24 lbs)						
5.2	13/64	0.207	30207	30m (100')	18 Kg (39 lbs)						
5.5	7/32	0.218	30218	30m (100')	22 Kg (49 lbs)						
7	9/32	0.281	30281	30m (100')	30 Kg (66 lbs)	30281D	244m (800')	233 Kg (515 lbs)			
8	5/16	0.312	30312	15m (50')	18 Kg (40 lbs)	30312D	213m (700')	250 Kg (550 lbs)	33312	15m (50')	18 Kg (40 lbs)
10	3/8	0.375	30375	15m (50')	29 Kg (64 lbs)	30375D	152m (500')	304 Kg (670 lbs)	33375	15m (50')	29 Kg (64 lbs)
11	7/16	0.437	30437	15m (50')	42 Kg (92 lbs)	30437D	91m (300')	236 Kg (520 lbs)	33437	15m (50')	42 Kg (92 lbs)
13.5	17/32	0.531	30531	15m (50')	64 Kg (140 lbs)	30531D	61m (200')	259 Kg (570 lbs)	33531	15m (50')	64 Kg (140 lbs)
19	3/4	0.750	30750	15m (50')	117 Kg (258 lbs)						

V-BAR

CARBON STEEL,
ROUND WIRE W/ REINFORCED V-BARS



LINK MATERIAL SIZE			BAG QUANTITY			DRUM QUANTITY		
mm	Inches	Gauge	Part #	Length / Bag	Weight / Bag	Part #	Length / Drum	Weight / Drum
5.5	7/32	0.218	38218	30m (100')	25 Kg (56 lbs)			
7	9/32	0.281	38281	15m (50')	20 Kg (43 lbs)	38281D	244m (800')	304 Kg (670 lbs)
8	5/16	0.312	38312	15m (50')	24 Kg (54 lbs)	38312D	213m (700')	322 Kg (710 lbs)
10	3/8	0.375	38375	15m (50')	36 Kg (80 lbs)	38375D	152m (500')	367 Kg (810 lbs)

SQUARE LINK ALLOY

ALLOY STEEL,
SQUARE WIRE



LINK MATERIAL SIZE			BAG QUANTITY			DRUM QUANTITY		
mm	Inches	Gauge	Part #	Length / Bag	Weight / Bag	Part #	Length / Drum	Weight / Drum
5.5	7/32	0.218	31218	30m (100')	21 Kg (47 lbs)			
7	9/32	0.281	31281	15m (50')	17 Kg (38 lbs)	31281D	183m (600')	209 Kg (460 lbs)
8	5/16	0.312	31312	15m (50')	22 Kg (48 lbs)	31312D	152m (500')	213 Kg (470 lbs)
10	3/8	0.375	31375	15m (50')	38 Kg (83 lbs)	31375D	91m (300')	195 Kg (430 lbs)
11	7/16	0.437	31437	15m (50')	48 Kg (106 lbs)	31437D	61m (200')	179 Kg (395 lbs)
13.5	17/32	0.531	31531	15m (50')	82 Kg (180 lbs)			

NORDIC™ STUDED

ALLOY STEEL
ROUND WIRE W/ REINFORCED STUDS



LINK MATERIAL SIZE			BAG QUANTITY		
mm	Inches	Gauge	Part #	Length / Bag	Weight / Bag
7	9/32	0.281	39281	30m (100')	41 Kg (90 lbs)
8	5/16	0.312	39312	15m (50')	28 Kg (62 lbs)
9.5	3/8	0.375	39375	15m (50')	36 Kg (79 lbs)
11	7/16	0.437	39437	15m (50')	53 Kg (117 lbs)
13.5	17/32	0.531	39531	15m (50')	72 Kg (158 lbs)

ACCESSORIES

STANDARD SIDE CHAIN

CARBON STEEL - STRAIGHT LINK



LINK MATERIAL SIZE			CARBON - BAG QUANTITY			CARBON - DRUM QUANTITY		
mm	Inches	Gauge	Part #	Length / Bag	Weight / Bag	Part #	Length / Drum	Weight / Drum
4.5	11/64	0.177	40177	30m (100')	10 Kg (23 lbs)			
4.8	3/16	0.192	40192	30m (100')	11 Kg (25 lbs)			
5.2	13/64	0.207	40207	30m (100')	14 Kg (30 lbs)			
5.5	7/32	0.218	40218	30m (100')	16 Kg (35 lbs)			
7	9/32	0.281	40281	30m (100')	24 Kg (53 lbs)	40281D	305m (1000')	250 Kg (550 lbs)
8	5/16	0.312	40312	30m (100')	31 Kg (69 lbs)	40312D	244m (800')	304 Kg (555 lbs)
10	3/8	0.375	40375	15m (50')	24 Kg (53 lbs)	40375D	152m (500')	236 Kg (520 lbs)
11	7/16	0.437	40437	15m (50')	34 Kg (75 lbs)	40437D	107m (350')	247 Kg (545 lbs)
13.5	17/32	0.531	40531	15m (50')	54 Kg (118 lbs)	40531D	61m (200')	211 Kg (465 lbs)

ALLOY SIDE CHAIN

ALLOY STEEL - STRAIGHT LINK - HARDENED



LINK MATERIAL SIZE			BAG QUANTITY		
mm	Inches	Gauge	Part #	Length / Bag	Weight / Bag
6.35	1/4	0.250	A40250H	30m (100')	20 Kg (44 lbs)
8	5/16	0.312	A40312H	30m (100')	31 Kg (69 lbs)
10	3/8	0.375	A40375H	15m (50')	24 Kg (53 lbs)
11	7/16	0.437	A40437H	15m (50')	34 Kg (75 lbs)
13.5	17/32	0.531	A40531H	15m (50')	54 Kg (118 lbs)

CAM SIDE CHAIN

PRE-CUT PIECES / FASTENER INCLUDED



LINK MATERIAL SIZE			CARBON STEEL				HARDENED ALLOY STEEL			
mm	Inches	Gauge	Part #	Length / Piece	Weight / Piece	End Fastener	Part #	Length / Drum	Weight / Drum	End Fastener
5.5	7/32	0.218	40218C	2.2m (86")	1.4 Kg (3 lbs)	15003				
6.35	1/4	0.250					A40250HC	3m (120")	2 Kg (5 lbs)	15NR4P
7	9/32	0.218	40281C	3m (120")	2.8 Kg (6 lbs)	15004				
8	5/15	0.312	40312C	3m (120")	3.9 Kg (9 lbs)	15004	A40312HC	3m (120")	4 Kg (9 lbs)	15NR6P

CAM LOCKS & CAM TOOLS

CARBON STEEL, INDIVIDUAL PIECES FOR WELDING ON SIDE CHAIN | CAM TOOLS



CAM LOCKS				CAM TOOLS			
Part #	For Side Chain Size	Application	Weight / Piece	Part #	Application	Weight	QTY
CAM4	5.5 mm (7/32")	Light Truck	0.5 Kg (1 lb)	T2800	T-Shape Heavy Truck	0.5 Kg (1 lb)	1
CAM6	7 mm (9/32")	Heavy Truck	0.5 Kg (1 lb)	T2801	T-Shape Light Truck	0.23 Kg (.5 lb)	1
CAM7	8 mm (5/16")	Heavy Truck	0.5 Kg (1 lb)	T2802	T-Shape LW Chains	0.23 Kg (.5 lb)	1
				L2800	L-Shape Heavy Truck	0.5 Kg (1 lb)	1
				L2801	L-Shape Light Truck	0.23 Kg (.5 lb)	1

ACCESSORIES

SIDE CHAIN FASTENERS

FOR CHAIN SIZE		APPLICATION	PART #	O.A.L	QTY / BAG	WEIGHT / BAG
mm	Inches					
6	1/4	Light Truck	15003	4"	25	2.3 Kg (5 lbs)
7 - 8	9/32 - 5/16	Medium & Heavy Duty Truck	15004	6"	25	5.4 Kg (12 lbs)
10 - 13	3/8 - 1/2	Heavy Grader	15008	7"	25	2.3 Kg (1 lb)



SIDE CHAIN FASTENERS BOOMERS

FOR CHAIN SIZE		APPLICATION	PART #	O.A.L	QTY / BAG	WEIGHT / BAG
mm	Inches					
6	1/4	Light Truck	15NR4P	5"	50	9 Kg (20 lbs)
7 - 8	9/32 - 5/16	Heavy Truck	15NR6P	7"	50	11.3 Kg (25 lbs)
10 - 13	3/8 - 1/2	Grader	15NR9P	9"	25	11.3 Kg (25 lbs)



SIDE CHAIN FASTENERS OUTER LOCK

FOR CHAIN SIZE		APPLICATION	PART #	O.A.L	QTY / BAG	WEIGHT / BAG
mm	Inches					
10 - 13	3/8 - 1/2	Heavy Grader	15005	6"	25	11.3 Kg (25 lbs)
7 - 8	8 - 10	Light Grader	15007	7"	25	4.8 Kg (10.5 lbs)



SIDE CHAIN FASTENERS

FOR CHAIN SIZE		APPLICATION	PART #	O.A.L	QTY / BAG	WEIGHT / BAG
mm	Inches					
4.5 - 6	11/64 - 1/4	Garden Tractor	5308	6"	25	4.5 Kg (10 lbs)



SIDE CHAIN FASTENERS

FOR CHAIN SIZE		APPLICATION	PART #	O.A.L	QTY / BAG	WEIGHT / BAG
mm	Inches					
4.5 - 6	11/64 - 1/4	Garden Tractor (Alloy)	A5308	3"	25	5.4 Kg (12 lbs)



ACCESSORIES

CROSS CHAIN HOOK

CARBON STEEL

LINK MATERIAL SIZE			APPLICATION	PART #	QTY / BAG	WEIGHT / BAG
mm	Inches	Gauge				
4.5	11/64	0.177	Passenger	20177	50	0.9 Kg (2 lbs)
5.2	13/64	0.207	Passenger	20230	50	1.8 Kg (4 lbs)
6.35	1/4	0.250	Light Truck	20250	50	2.3 Kg (5 lbs)
8	5/16	0.312	Medium Truck	20312	50	3.6 Kg (8 lbs)
9.5	3/8	0.375	Heavy Truck	20375	50	5.4 Kg (12 lbs)
10.3	13/32	0.406	Tractor	20406	50	7.7 Kg (17 lbs)
11	7/16	0.437	Grader	20437	50	10 Kg (22 lbs)
13.5	17/32	0.531	Loader	20531	25	12.7 Kg (28 lbs)



ALLOY CROSS CHAIN HOOK

HARDENED ALLOY STEEL

LINK MATERIAL SIZE			APPLICATION	PART #	QTY / BAG	WEIGHT / BAG
mm	Inches	Gauge				
8	5/16	0.312	Medium Truck	A20312LW	50	3.4 Kg (7.5 lbs)
8	5/16	0.312	Medium Truck	A20312H	50	3.4 Kg (7.5 lbs)
9	11/32	0.344	Heavy Truck	A20344H	50	5.7 Kg (12.5 lbs)
10	25/64	0.393	Tractor	A20393H	50	7.9 Kg (17.5 lbs)
11	7/16	0.437	Grader	A20437SH	50	7.9 Kg (17.5 lbs)
11	7/16	0.437	Grader	A20437H	50	7.9 Kg (17.5 lbs)
13.5	17/32	0.531	Loader	A20531H	25	8.5 Kg (18.7 lbs)



SWIVEL "J" CROSS CHAIN HOOK

CARBON STEEL

Allows for cross chains to be removed by hand. No pliers or tools required.

LINK MATERIAL SIZE			APPLICATION	PART #	QTY / BAG	WEIGHT / BAG
mm	Inches	Gauge				
11	7/16	0.437	Loader / Grader / Tractor (3/8" cross chain)	20451JHNW (No Washer)	50	5.9 Kg (13 lbs)
14	9/16	0.563	Loader / Grader / Tractor (7/16" cross chain)	20450JH	50	6.4 Kg (14 lbs)



QUICK HOOK (INSIDE HOOK)

HARDENED ALLOY STEEL

Connecting links.

TYPE	WIRE SIZE		APPLICATION	PART #	FOR CHAIN SIZE			QTY / BAG	WEIGHT / BAG
	mm	Inches			mm	Inches	Inside Length		
R	5.5	7/32	Passenger	10218	5.5	7/32	47.6mm (1-7/8")	25	0.5 Kg (1 lb)
R	6.35	1/4	Garden Tractor	10250	6.35	1/4	47.6mm (1-7/8")	25	0.5 Kg (1 lb)
R	7	9/32	Light Truck	10281	7	9/32	54mm (2-1/8")	25	0.9 Kg (2 lbs)
R	8	5/16	Medium Truck (Polished)	10312P	7-8	9/32 - 5/16		25	0.9 Kg (2 lbs)
R	9.5	5/16 - 3/8	Heavy Truck	10375	9.5	3/8	54mm (2-1/8")	25	1.8 Kg (4 lbs)
R	10.3	13/32	Off-Road (Polished)	10406P	8 - 10	5/16 - 3/8		25	2.7 Kg (6 lbs)
H	13.5	17/32	Loader/Grader (Hex Wire)	10531H	11 - 13	7/16 - 1/2		50	14.5 Kg (32 lbs)
F	6	1/4	Off-Road (Flat Style)	07N95	6	1/4		100	9.1 Kg (20 lbs)
F	7 - 8	9/32 - 5/16	Off-Road (Flat Style)	10N95	8	5/16	54mm (2-1/8")	50	5.9 Kg (13 lbs)

Round Wire (R)



Hex Wire (H)



Flat European Style (F)



ACCESSORIES

CROSS CHAIN REPAIR LINK

LINK MATERIAL SIZE		APPLICATION	PART #	QTY / BAG	WEIGHT / BAG
mm	Inches				
8	5/16	Heavy Truck	9273	50	2.3 Kg (5 lbs)
9.5	3/8	Square Link	9280	50	3.6 Kg (8 lbs)
11	7/16	Square Link	9282	50	5.9 Kg (13 lbs)
13.5	17/32	Square Link	9284	50	10 Kg (22 lbs)



SIDE CHAIN REPAIR LINK

FOR CHAIN SIZE		APPLICATION	INSIDE LENGTH	PART #	QTY / BAG	WEIGHT / BAG
mm	Inches					
6.35	1/4	Passenger	31.75mm (1-1/4")	9116B	50	1.4 Kg (3 lbs)
8	5/16	Medium Truck	38.1mm (1-1/2")	9116C	50	3.2 Kg (7 lbs)
9.5	3/8	Grader	41.28mm (1-5/8")	9116D	50	5 Kg (11 lbs)
11	7/16	Loader	63.5mm (2-1/2")	9116E	10	1.7 Kg (3 lbs)
12.7	1/2	Loader	82.55mm (3-1/4")	9116F	10	2.3 Kg (5 lbs)



REPAIR RINGS

To repair Net Link chains

RING WIRE SIZE		APPLICATION	INSIDE LENGTH	PART #	QTY / BAG	WEIGHT / BAG
mm	Inches					
16	5/8	Loader / Grader / Skidder	76.2 mm (3")	RING16	1	0.06 Kg (1 lb)
18	3/4	Skidder	76.2 mm (3")	RING18	1	0.06 Kg (1 lb)
22	1/2	Skidder	76.2 mm (3")	RING22	1	0.06 Kg (1 lb)



QUICK LINKS

Fast, easy connections for permanent or temporary attachment. For applications with low carbon chains only

FOR CHAIN SIZE		DIMENSIONS mm / Inches				PART #	WORKING LOAD LIMIT	QTY / BAG	WEIGHT / BAG
mm	Inches	A	B	C	D				
3.5	1/8	28.7 (1.13)	35.05 (1.38)	9.65 (0.38)	4.82 (0.19)	QL125	99.8 Kg (220 lbs)	10	0.09 Kg (0.2 lb)
4.8	3/16	38.1 (1.50)	47.75 (1.88)	12.7 (0.50)	6.35 (0.25)	QL192	276.7 Kg (610 lbs)	10	0.18 Kg (0.4 lb)
6.35	1/4	44.45 (1.75)	57.15 (2.25)	14.22 (0.56)	7.11 (0.28)	QL281	399.2 Kg (880 lbs)	10	0.36 Kg (0.8 lb)
8	5/16	58.67 (2.31)	73.15 (2.88)	17.53 (0.69)	9.65 (0.38)	QL312	698.5 Kg (1540 lbs)	10	0.73 Kg (1.6 lbs)
9.5	3/8	61.98 (2.44)	79.5 (3.13)	19.05 (0.75)	11.18 (0.44)	QL375	8980.1 Kg (1980 lbs)	10	1.1 Kg (2.4 lbs)
11	7/16	68.33 (2.69)	88.9 (3.50)	20.57 (0.81)	12.7 (0.50)	QL437	1324.4 Kg (2920 lbs)	10	1.7 Kg (3.8 lbs)
12.7	1/2	81.03 (3.19)	104.9 (4.13)	23.88 (0.94)	16 (0.63)	QL531	1496.9 Kg (3300 lbs)	10	2.5 Kg (5.6 lbs)

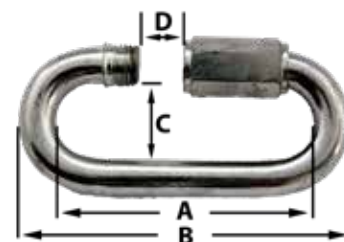

ACCESSORIES

RATED ANCHOR SHACKLES

GALVANIZED, ALLOY STEEL, RATED BLACK PIN
Meets U.S. Specs RRC-271D (Type 4A, Grade A, Class D)

SIZE		WORKING LOAD LIMIT (1T = 2000 lbs)	PART #	QUANTITY	WEIGHT
mm	Inches				
9.5	3/8	2000 Kg (1 T)	SPAS100-IM	1	0.14 Kg (0.30 lb)
12.7	1/2	2000 Kg (2 T)	SPAS125-IM	1	0.33 Kg (0.72 lb)
16	5/8	3250 Kg (3.25 T)	SPAS160-IM	1	0.64 Kg (1.4 lbs)
19	3/4	4750 Kg (4.75 T)	SPAS190-IM	1	1.1 Kg (2.5 lbs)
22	7/8	6500 Kg (6.5 T)	SPAS220-IM	1	1.6 Kg (3.6 lbs)
25	1	8500 Kg (8.5 T)	SPAS250-IM	1	2.4 Kg (5.2 lbs)
28	1 1/8	9500 Kg (9.5 T)	SPAS280-IM	1	3.4 Kg (7.4 lbs)
32	1 1/4	12000 Kg (12 T)	SPAS320-IM	1	4.3 Kg (9.5 lbs)
35	1 3/8	13500 Kg (13.5 T)	SPAS350-IM	1	6.1 Kg (13.5 lbs)
38	1 1/2	17000 Kg (17 T)	SPAS380-IM	1	7.8 Kg (17.2 lbs)
44	1 3/4	25000 Kg (25 T)	SPAS440-IM	1	12.6 Kg (27.8 lbs)
50	2	35000 Kg (35 T)	SPAS500-IM	1	20.4 Kg (45 lbs)



ANCHOR SHACKLES

GALVANIZED, NON RATED

SIZE		PART #	QUANTITY	WEIGHT
mm	Inches			
4.8	3/16	SPAS048-NR	1	0.03 Kg (0.06 lb)
6.35	1/4	SPAS064-NR	1	0.06 Kg (0.12 lb)
8	5/16	SPAS080-NR	1	0.08 Kg (0.18 lb)
9.5	3/8	SPAS100-NR	1	0.15 Kg (0.32 lb)
11	7/16	SPAS110-NR	1	0.21 Kg (0.45 lb)
12.7	1/2	SPAS125-NR	1	0.31 Kg (0.68 lb)
16	5/8	SPAS160-NR	1	0.62 Kg (1.36 lbs)
19	3/4	SPAS190-NR	1	1.02 Kg (2.24 lbs)



PIN COUPLER SHACKLES

STANDARD | LOCKING / RETAINER INCLUDED

SIZE		PART #	QUANTITY	WEIGHT
mm	Inches			
6	1/4	PCS-065	1	0.03 Kg (0.06 lb)
8	5/16	PCS-085	1	0.04 Kg (0.09 lb)
10	3/8	PCS-100	1	0.05 Kg (0.11 lb)
13	1/2	PCS-130	1	0.09 Kg (0.20 lb)
16	5/8	PCS-160	1	0.31 Kg (0.68 lb)
19	3/4	PCS-190	1	0.53 Kg (1.17 lbs)
22	7/8	PCS-220	1	0.75 Kg (1.65 lbs)
25	1	PCS-250	1	0.78 Kg (1.72 lbs)
20	25/32	PLC-20	1	1.25 Kg (2.75 lbs)



Standard



Locking (PLC) comes w/ Retainer

SINGLE MOUNTS (SINGLES)



1/2 pair of singles shown.
Cross chains span the width of one tire.

TRIPLE MOUNTS (TRIPLES)



1/2 pair of triples shown. Centre side chain rail lies in-between the two tandem tires of a dual axle set up.

Advantage: Centre rail helps keep the cross chains from shifting and twisting.

ANATOMY OF A TIRE CHAIN



1. Fastener

(boomer) Joins and secures the ends of the chain together.

2. Quick Hook

(C-hook) inside hook.

3. Cross Chain

(cross links) Provides traction with the ground surface.

4. Cross Chain Hook

Secures cross chains to the side chain.

5. Side Chain

(side rails) Acts as the frame for tire chain construction.

6. Centre Rail

(triples only) Side chain in the middle of a 1/2 set of triple chains.

7. Cams/Cam Side Chain

Side chain with cams is available to make tightening chain easier.

Contact QCCanada for product information or application questions.

Our Other Products

Ground Engaging Tools

Bucket teeth

Cutting edges

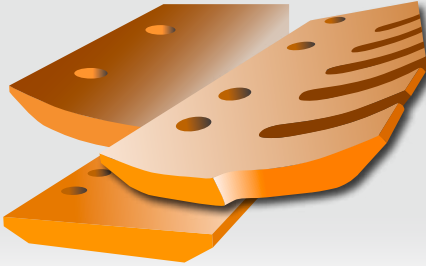

Nova Forestry

Saw teeth

Flail chain



Cargo Control

Grade 70 bulk

Grade 70 pre-cut

Ratchet & swivel load binders



Industrial Supply

Grade 30/43 / Mooring Chain

BBB - Windlass

Anchor shackles



QCCANADA



TRACTION CATALOGUE



www.westcoastwearproducts.com
1-866-307-6622

sales@westcoastwearproducts.com
106 – 5769 Production Way
Langley, BC V3A 4N4